

# VARISPEED-676GL5 INSTRUCTION MANUAL

VECTOR-CONTROLLED INVERTER DRIVES FOR ELEVATORS (VS-676GL5)

MODEL: CIMR-L5A□□□□

200V CLASS 4.5 to 45kW

400V CLASS 4.5 to 45kW

---

Upon receipt of the product and prior to initial operation, read these instructions thoroughly, and retain for future reference.

---



---

# PREFACE

This instruction manual describes installation, maintenance and inspection, troubleshooting, and specifications of the VS-676GL5. Read this instruction manual thoroughly before operation.

YASKAWA ELECTRIC CORPORATION

## General Precautions

- Some drawings in this manual are shown with the protective cover or shields removed, in order to describe detail with more clarity. Make sure all covers and shields are replaced before operating this product
- This manual may be modified when necessary because of improvement of the product, modification, or changes in specifications.  
Such modifications are denoted by a revised manual No.
- To order a copy of this manual, if your copy has been damaged or lost, contact your YASKAWA representative.
- YASKAWA is not responsible for any modification of the product made by the user, since that will void your guarantee.

## NOTES FOR SAFE OPERATION

Read this instruction manual thoroughly before installation, operation, maintenance or inspection of the VS-676GL5. In this manual, NOTES FOR SAFE OPERATION are classified as "WARNING" or "CAUTION".

### WARNING

Indicates a potentially hazardous situation which, if not avoided, could result in death or serious injury to personnel.

### CAUTION

Indicates a potentially hazardous situation which, if not avoided, may result in minor or moderate injury to personnel and damage to equipment.

It may also be used to alert against unsafe practices.

Even items described in  CAUTION may result in a vital accident in some situations. In either case, follow these important notes.

 NOTE

: These are steps to be taken to insure proper operation.

## RECEIVING

### CAUTION

- Do not install or operate any inverter which is damaged or has missing parts.

Failure to observe this caution may result in personal injury or equipment damage.

(Ref. page)

10

## INSTALLATION



### CAUTION

(Ref. page)

- Lift the cabinet by the base. When moving the unit, never lift by the front cover.  
Otherwise, the main unit may be dropped causing damage to the unit. . . . . 12
- Mount the inverter on nonflammable material (i.e. metal).  
Failure to observe this caution can result in a fire. . . . . 12
- When mounting units in an enclosure, install a fan or other cooling device to keep the intake air temperature below 45°C.  
Overheating may cause a fire or damage to the unit. . . . . 12

## WIRING



### WARNING

(Ref. page)

- Only commence wiring after verifying that the power supply is turned OFF.  
Failure to observe this warning can result in an electrical shock or a fire. . . . . 16
- Wiring should be performed only by qualified personnel.  
Failure to observe this warning can result in an electrical shock or a fire. . . . . 16
- When wiring the emergency stop circuit, check the wiring thoroughly before operation.  
Failure to observe this warning can result in personal injury. . . . . 16
- Make sure to ground the ground terminal .  
(Ground resistance  
200V class: 100Ω or less, 400V class: 10Ω or less)  
Failure to observe this warning can result in an electrical shock or a fire. . . . . 19



## CAUTION

(Ref. page)

- Verify that the inverter rated voltage coincides with the AC power supply voltage.  
Failure to observe this caution can result in personal injury or a fire. .... 16
- Do not perform a withstand voltage test of the inverter.  
It may cause semi-conductor elements to be damaged. .... 16
- To connect a braking resistor, braking resistor unit or braking unit, follow the procedures described in APPENDIX 3.  
Improper connection may cause a fire. .... 16
- Tighten terminal screws to the specified tightening torque.  
Failure to observe this caution can result in a fire. .... 16
- Never connect the AC main circuit power supply to output terminals U, V and W.  
The inverter will be damaged and invalidate the guarantee. .... 19

### SETTING OPERATION CONDITIONS



## CAUTION

(Ref. page)

- Never connect the motor to the load (machines or equipment) when conducting auto-tuning.  
Motor rotation may cause injury or equipment damage as well as incorrect motor constant settings. .... 31

## OPERATION



### WARNING

(Ref. page)

- Only turn ON the input power supply after replacing the front cover. Do not remove the cover while current is flowing.  
Failure to observe this warning can result in an electrical shock. . . . . 65
- When the retry function (L5-02) is selected, do not approach the inverter or the load, since it may restart suddenly after being stopped.  
(Construct machine system, so as to assure safety for personnel, even if the inverter should restart.)  
Failure to observe this warning can result in personal injury. . . . . 65
- Since the stop button can be disabled by a function setting, install a separate emergency stop switch.  
Failure to observe this warning can result in personal injury. . . . . 65
- If an alarm is reset with the operation signal ON, the inverter restarts automatically. Only reset the alarm after verifying that the operation signal is OFF.  
Failure to observe this warning can result in personal injury. . . . . 65





### CAUTION

(Ref. page)

- Never touch the heatsink or discharging resistor since the temperature is very high.  
Failure to observe this caution can result in harmful burns to the body. . . . . 65
- Since it is easy to change operation speed from low to high speed, verify the safe working range of the motor and machine before operation.  
Failure to observe this caution can result in personal injury and machine damage. . . 65
- Install a holding brake separately if necessary.  
Failure to observe this caution can result in personal injury. . . . . 65
- Do not change signals during operation.  
The machine or the inverter may be damaged. . . . . 65
- All the constants of the inverter have been preset at the factory. Do not change the settings unnecessarily.  
The inverter may be damaged. For supply voltage, follow Par. 4.3. . . . . 65

MAINTENANCE AND INSPECTION

 <b>WARNING</b>
<div style="text-align: right;">(Ref. page)</div> <ul style="list-style-type: none"> <li>• Never touch high-voltage terminals in the inverter. Failure to observe this warning can result in an electrical shock. .... 74</li> <li>• Replace all protective covers before powering up the inverter. To remove the cover, make sure to shut OFF the molded-case circuit breaker. Failure to observe this warning can result in an electrical shock. .... 74</li> <li>• Perform maintenance or inspection only after verifying that the CHARGE LED goes OFF, after the main circuit power supply is turned OFF. The capacitors are still charged and can be dangerous. .... 74</li> <li>• Only authorized personnel should be permitted to perform maintenance, inspections or parts replacement. [Remove all metal objects (watches, bracelets, etc.) before operation.] (Use tools which are insulated against electrical shock.) Failure to observe this warning can result in an electrical shock. .... 74</li> </ul>

 <b>CAUTION</b>
<div style="text-align: right;">(Ref. page)</div> <ul style="list-style-type: none"> <li>• The control PC board employs CMOS ICs. Do not touch the CMOS elements. They are easily damaged by static electricity. .... 74</li> <li>• Do not connect or disconnect wires or connectors while power is applied to the circuit. Failure to observe this caution can result in personal injury. .... 74</li> </ul>

OTHERS

 <b>WARNING</b>
<ul style="list-style-type: none"> <li>• Never modify the product. Failure to observe this warning can result in an electrical shock or personal injury and will invalidate the guarantee.</li> </ul>

## WARNING LABEL

A warning label is displayed on the front cover of the inverter, as shown below. Follow these instructions when handling the inverter.

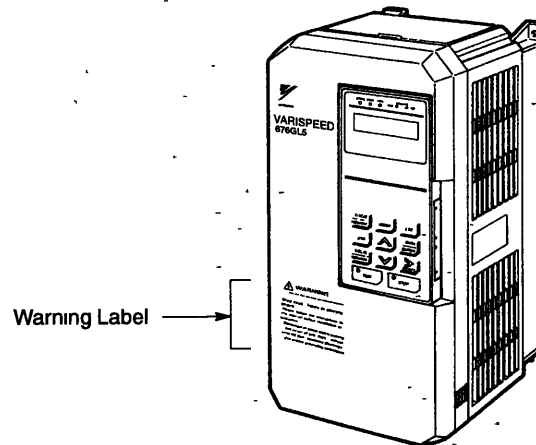

Model CIMR-L5A24P5

### Warning Label

 <b>WARNING</b>
<p>May cause injury or electric shock.</p> <ul style="list-style-type: none"><li>• Please follow the instructions in the manual before installation or operation.</li><li>• Disconnect all power before opening front cover of unit. Wait 1 minute until DC Bus capacitors discharge.</li><li>• Use proper grounding techniques.</li></ul>



# CONTENTS

NOTES FOR SAFE OPERATION .....	3
1 RECEIVING .....	10
1.1 INSPECTION CHECKPOINTS .....	10
1.2 IDENTIFYING THE PARTS .....	11
2 INSTALLATION .....	12
2.1 REMOVING AND REPLACING THE DIGITAL OPERATOR .....	12
2.2 REMOVING AND REPLACING THE FRONT COVER .....	13
2.3 CHOOSING A LOCATION TO MOUNT THE INVERTER .....	14
2.4 CLEARANCES .....	15
3 WIRING .....	16
3.1 CONNECTION DIAGRAM .....	17
3.2 WIRING THE MAIN CIRCUIT .....	19
3.3 WIRING THE CONTROL CIRCUIT .....	29
3.4 WIRING INSPECTION .....	30
4 SETTING OPERATION CONDITIONS .....	31
4.1 DIGITAL OPERATOR KEY DESCRIPTION .....	31
4.2 DIGITAL OPERATOR MODE .....	33
5 OPERATION .....	65
5.1 OPERATION MODE SELECTION .....	66
5.2 TEST RUN CHECKPOINTS .....	67
5.3 SETTING THE LINE VOLTAGE USING JUMPER (FOR 400V CLASS 13kW AND ABOVE) .....	67
5.4 TEST RUN .....	68
6 MAINTENANCE AND INSPECTION .....	74
6.1 PERIODIC INSPECTION .....	75
6.2 PARTS REPLACEMENT SCHEDULE (GUIDELINES) .....	75
7 TROUBLESHOOTING .....	76
7.1 FAULT DIAGNOSIS AND CORRECTIVE ACTIONS .....	76
7.2 MOTOR FAULTS AND CORRECTIVE ACTIONS .....	81
APPENDIX 1 SPECIFICATIONS .....	82
APPENDIX 2 DIMENSIONS (mm) .....	86
APPENDIX 3 TYPICAL CONNECTION DIAGRAM .....	87
3.1 BRAKING RESISTOR UNIT .....	87
3.2 BRAKING UNIT AND BRAKING RESISTOR UNIT .....	88
3.3 THREE BRAKING UNITS IN PARALLEL .....	91
3.4 VS OPERATOR MODELS JVOP-95 AND JVOP-96 .....	93
3.5 SEQUENCE INPUT AND OUTPUT CONNECTION WITH NPN TRANSISTOR (0V COMMON) .....	94
3.6 SEQUENCE INPUT AND OUTPUT CONNECTION WITH PNP TRANSISTOR (SUPPLY SIDE COMMON) .....	95
3.7 WITH CONTACT OUTPUT, OPEN COLLECTOR OUTPUT .....	96

# 1 RECEIVING

⚠ CAUTION
<ul style="list-style-type: none"> <li>Do not install or operate any inverter which is damaged or has missing parts. Failure to observe this caution may result in personal injury or equipment damage</li> </ul>

This chapter describes how to verify the inverter after delivery to the user.

## 1.1 INSPECTION CHECKPOINTS

### (1) Receiving Checkpoints

Table 1 Checkpoints

Checkpoints	Description
Does the inverter model number correspond with the purchase order?	Check the model number on the nameplate on the side of the VS-676GL5 (Refer to page 11.)
Are any parts damaged?	Visually check the exterior and verify that there was no damage during transport
Is hardware properly seated and securely tightened?	Remove inverter front cover Check all visible hardware with appropriate tools
Was an instruction manual received?	VS-676GL5 instruction manual (No TOE-S676-8)

If any of the above checkpoints are not satisfactory, contact your YASKAWA representative.

### (2) Checking the Nameplate Data

#### (a) Nameplate Data

Example of Japan domestic standard model CIMR-L5A24P5 (200VAC 4.5kW, NEMA 1)

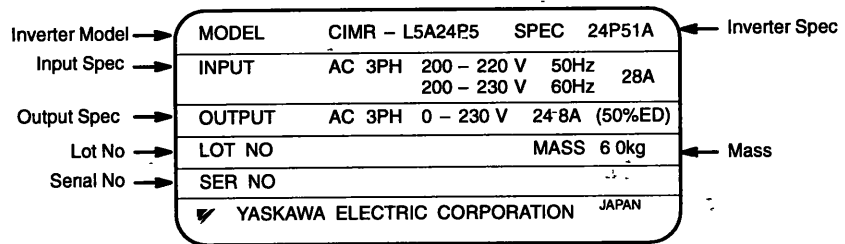

Fig. 1 Nameplate Data

(b) Model Designation

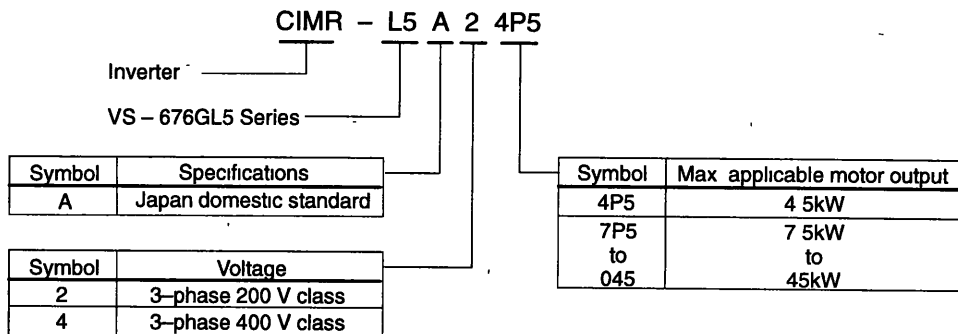
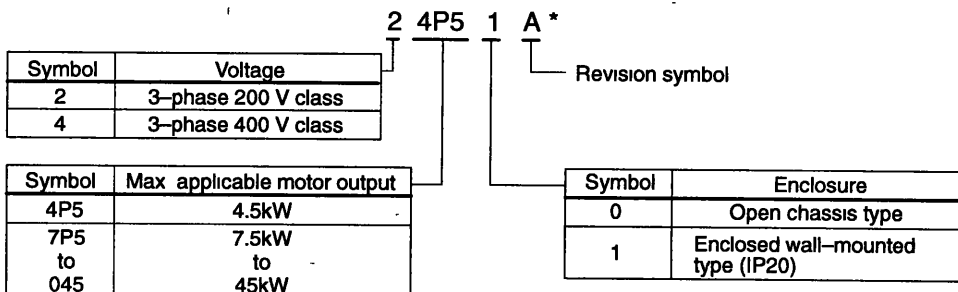

Fig. 2 Model Designation

(c) Specification Designation



\* For special specifications, a spec. sheet No. appears on the nameplate

Fig. 3 Specification Designation

1.2 IDENTIFYING THE PARTS

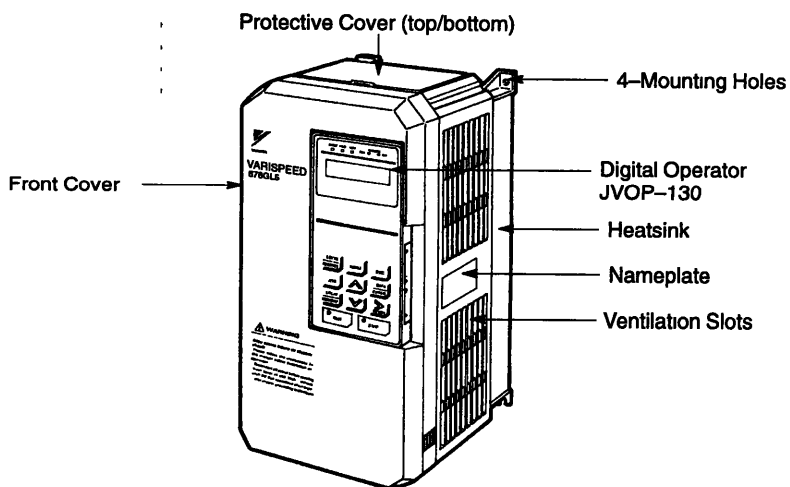

Fig. 4 Configuration of VS-676GL5 (Model CIMR-L5A24P5)

## 2 INSTALLATION

### CAUTION

- Lift the cabinet by the base. When moving the unit, never lift by the front cover. Otherwise, the main unit may be dropped causing damage to the unit.
- Mount the inverter on nonflammable material (i.e. metal). Failure to observe this caution can result in a fire.
- When mounting units in an enclosure, install a fan or other cooling device to keep the intake air temperature below 45°C. Overheating may cause a fire or damage to the unit.

This chapter describes the configuration, location and space when mounting the VS-676GL5.

### 2.1 REMOVING AND REPLACING THE DIGITAL OPERATOR

Remove and replace the digital operator as follows.

#### (1) Removing the Digital Operator

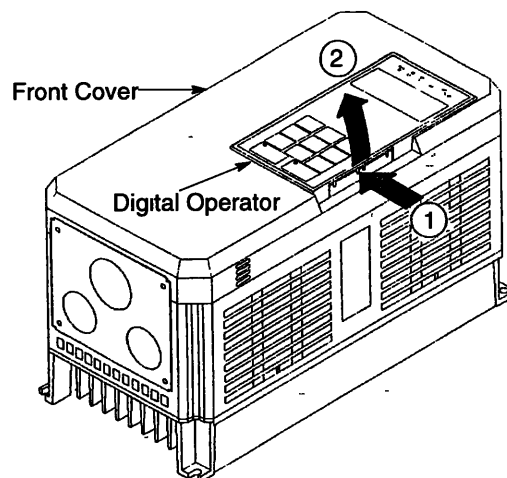

Push the digital operator lever in the direction shown by arrow 1 and lift the digital operator in the direction shown by arrow 2 to remove the digital operator from the front cover.

Fig. 5 Removing the Digital Operator

## (2) Replacing the Digital Operator

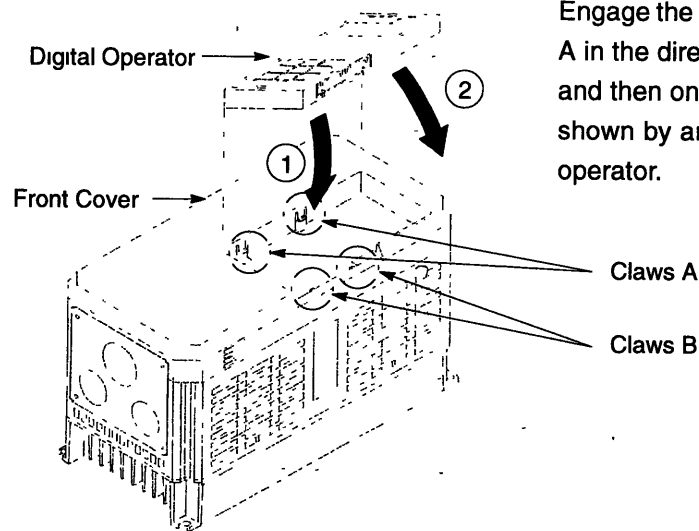

Engage the digital operator on claws A in the direction shown by arrow 1 and then on claws B in the direction shown by arrow 2 to lock the digital operator.

Fig. 6 Replacing the Digital Operator

## NOTE

Never fit the digital operator in any other direction or by any other method.  
The digital operator will not be connected to the inverter.

## 2.2 REMOVING AND REPLACING THE FRONT COVER

To remove the front cover, first move the digital operator in the direction shown by arrow 1. (See Par. 2.1.) Then squeeze the cover in the direction shown by arrows 2 on both sides and lift in the direction shown by arrow 3.

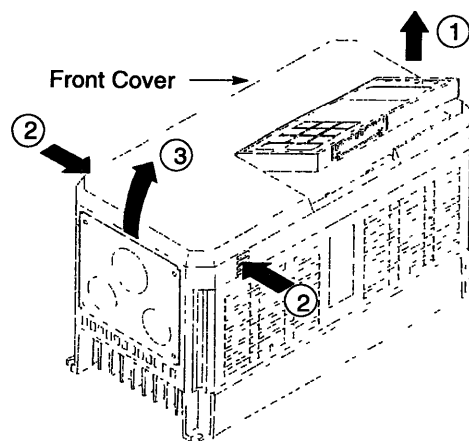

Fig. 7 Removing and Replacing the Front Cover

---

**NOTE**

Do not replace the front cover with the digital operator connected. The digital operator will not be connected to the inverter. Replace the front cover first and then install the digital operator on the cover. See Par. 2.1 for replacing the digital operator.

---

## 2.3 CHOOSING A LOCATION TO MOUNT THE INVERTER

To ensure proper performance and long operating life, follow the recommendations below when choosing a location for installing the VS-676GL5. Make sure the inverter is protected from the following conditions:

- Extreme cold and heat.  
Use only within ambient temperature range:  $-10^{\circ}\text{C}$  to  $+40^{\circ}\text{C}$
- Rain, moisture. (For enclosed wall-mounted type)
- Oil sprays, splashes
- Salt spray.
- Direct sunlight. (Avoid using outdoors )
- Corrosive gases or liquids.
- Dust or metallic particles in the air. (For enclosed wall-mounted type)
- Physical shock, vibration.
- Magnetic noise. (Example: welding machines, power devices, etc.)
- High humidity.
- Radioactive materials.
- Combustibles: thinners, solvents, etc

## 2.4 CLEARANCES

Install the VS-676GL5 vertically and allow sufficient clearances for effective cooling as shown in Fig. 8.

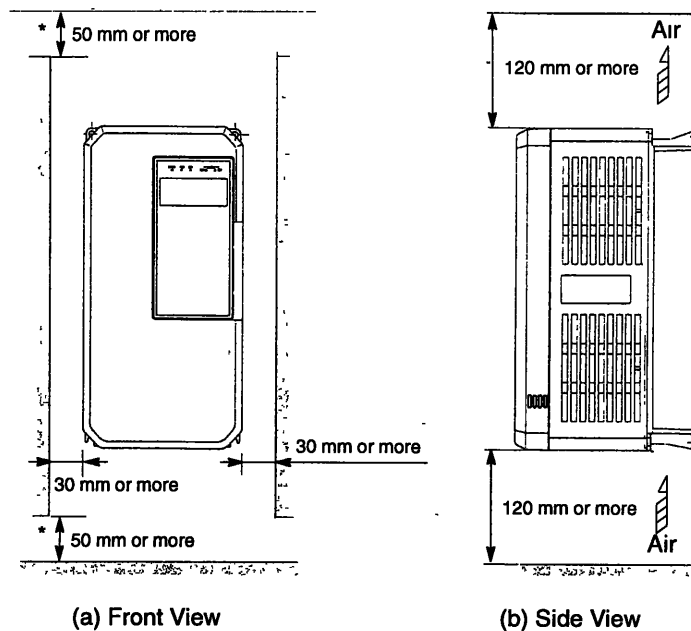

Fig. 8 Clearances

### NOTE

1. The clearances required at top/bottom and both sides are common in open chassis type (IP00) and enclosed wall-mounted type (IP20).
2. Remove the top and bottom covers to use the open chassis type of 200V 11kW / 400V 9.5kW or less.
3. When installing the models of 200V / 400V 22kW or more equipped with eyebolts, extra spacing will be required on either side. For detailed dimensions, contact your YASKAWA representative.
4. For the external dimensions and mounting dimensions, refer to APPENDIX 2 "DIMENSIONS".
5. Allowable intake air temperature to the inverter:
 

Open chassis type	: -10°C to +45°C
Enclosed wall-mounted type	: -10°C to +40°C
6. Ensure sufficient space for the sections at the upper and lower parts marked with \* in order to permit the flow of intake/exhaust air to/from the inverter.

### 3 WIRING



#### WARNING

- Only commence wiring after verifying that the power supply is turned OFF.  
Failure to observe this warning can result in an electrical shock or a fire.
- Wiring should be performed only by qualified personnel.  
Failure to observe this warning can result in an electrical shock or a fire.
- When wiring the emergency stop circuit, check the wiring thoroughly before operation.  
Failure to observe this warning can result in personal injury.



#### CAUTION

- Verify that the inverter rated voltage coincides with the AC power supply voltage.  
Failure to observe this caution can result in personal injury or a fire.
- Do not perform a withstand voltage test of the inverter.  
It may cause semi-conductor elements to be damaged.
- To connect a braking resistor, braking resistor unit or braking unit, follow the procedures described in APPENDIX 3.  
Improper connection may cause a fire.
- Tighten terminal screws to the specified tightening torque.  
Failure to observe this caution can result in a fire.

This chapter describes the main circuit wiring and the control circuit wiring of the VS-676GL5.



### 3.1 CONNECTION DIAGRAM

Below is a connection diagram of the main circuit and control circuit. Using the digital operator, the motor can be operated by wiring the main circuit only.

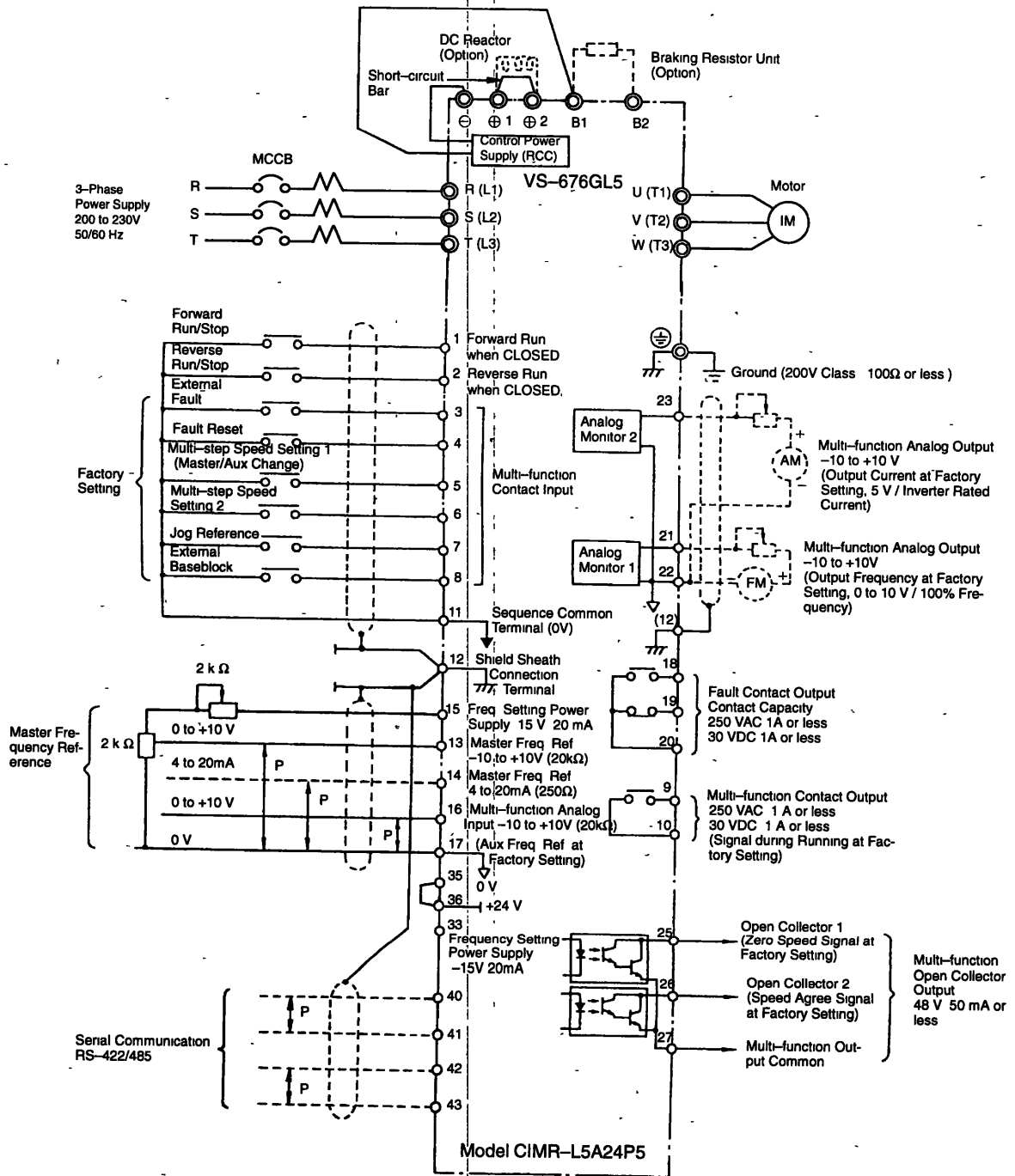
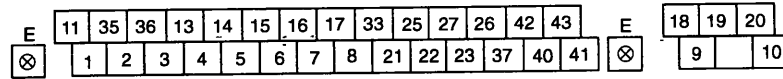



Fig. 9 Connection Diagram

NOTE

Layout of control circuit terminals



NOTE

1.  indicates shielded wires and  indicates twisted-pair shielded wires.
2. Either control circuit terminal 13 or 14 can be used. (For simultaneous inputs, the two signals are added internally.)
3. Control circuit terminal 15/33 of +15 V/-15 V has a maximum output current capacity of 20 mA.
4. Multi-function analog output should be used for monitoring meters (e.g. output frequency meter) and should not be used for feedback control system. Use analog monitor cards (Model AQ-08 or AO-12) for the control system, for a more accurate signal.
5. When using a braking resistor unit, set the constant L3-04 to "0" (stall prevention level during decel is "disabled") If it is not changed, the motor may not stop within the set decel time.
6. When using model ERF braking resistor (inverter-mounted type), set the braking resistor protection selection to "enabled". If it is not changed, the braking resistor cannot be protected.
7. When installing a DC reactor (optional for models of 200V 11kW / 400V 9.5kW or below), remove the short-circuit bar between ⊕1 and ⊕2 terminals and connect a DC reactor with the terminals.

## 3.2 WIRING THE MAIN CIRCUIT



### WARNING

- Make sure to ground the ground terminal  $\oplus$ .  
(Ground resistance 200V class: 100 $\Omega$  or less, 400V class: 10 $\Omega$  or less)  
Failure to observe this warning can result in an electrical shock or a fire.



### CAUTION

- Never connect the AC main circuit power supply to output terminals U, V and W.  
The inverter will be damaged and invalidate the guarantee.

#### (1) Wiring Precautions for Main Circuit Input

##### (a) Installation of Molded-case Circuit Breaker (MCCB)

Make sure to connect MCCBs or fuses between the AC main circuit power supply and VS-676GL5 input terminals R (L1), S (L2) and T (L3) to protect wiring.

##### (b) Installation of Ground Fault Interrupter

When connecting a ground fault interrupter to input terminals R (L1), S (L2) and T (L3), select one that is not affected by high frequency.

Examples: NV series by Mitsubishi Electric Co., Ltd. (manufactured in or after 1988),  
EG, SG series by Fuji Electric Co., Ltd. (manufactured in or after 1984)

##### (c) Installation of Magnetic Contactor

Inverter can be used without a magnetic contactor (MC) installed at the power supply side. When the main circuit power supply is shut OFF in the sequence, a magnetic contactor (MC) can be used instead of a molded-case circuit breaker (MCCB). However, when a magnetic contactor is switched OFF at the primary side, regenerative braking does not function and the motor coasts to a stop.

- The load can be operated/stopped by opening/closing the magnetic contactor at the primary side. However, frequent switching may cause the inverter to malfunction.
- When using a braking resistor unit, use a sequencer to break power supply side on overload relay trip contact. If the inverter malfunctions, the braking resistor unit may be burned out.

##### (d) Terminal Block Connection Sequence

Input power supply phases can be connected to any terminal regardless of the order of R (L1), S (L2) and T (L3) on the terminal block.

(e) Installation of Reactor

When connecting an inverter (200V/400V 11kW or less) to a large capacity power supply transformer (600kVA or more), or when switching a phase advancing capacitor, excessive peak current flows in the input power supply circuit, which may damage the converter section. In such cases, install a DC reactor (optional) between inverter ⊕1 and ⊕2 terminals or an AC reactor (optional) on the input side. Installation of a reactor is effective for improvement of power factor on the power supply side.

(f) Installation of Surge Suppressor

For inductive loads (magnetic contactors, magnetic relays, magnetic valves, solenoids, magnetic brakes, etc.) connected near the inverter, use a surge suppressor simultaneously.

(g) Prohibition of Installation of Phase Advancing Capacitor

If a phase advancing capacitor or surge suppressor is connected in order to improve the power factor, it may become overheated and damaged by inverter high harmonic components. Also, the inverter may malfunction because of overcurrent.

(2) Wiring Precautions for Main Circuit Output

(a) Connection of Terminal Block and Load

Connect output terminals U(T1), V(T2) and W(T3) to motor lead wires U(T1), V(T2) and W(T3). Verify that the motor rotates in the forward direction (CCW: counterclockwise when viewed from the motor load side) with the forward run command. If the motor rotation is incorrect, exchange any two of output terminals U(T1), V(T2) or W(T3).

(b) Strict Prohibition of Connection of Input Power Supply to Output Terminals

Never connect the input power supply to output terminals U(T1), V(T2) and W(T3).

(c) Strict Prohibition of Short Circuiting or Grounding of Output Circuit

Never touch the output circuit directly or put the output line in contact with the inverter case. Otherwise, it may cause an electrical shock or grounding. In addition, never short circuit the output line.

(d) Prohibition of Connection of Phase Advancing Capacitor or LC/RC Line Filter

Never connect a phase advancing capacitor or LC/RC line filter to the output circuit.

(e) Avoidance of Installation of Magnetic Starter

Do not connect a magnetic starter or magnetic contactor to the output circuit. If the load is connected while the inverter is running, the inverter overcurrent protective circuit operates because of inrush current.

## (f) Installation of Thermal Overload Relay

An electronic overload protective function is incorporated into the inverter. However, connect a thermal overload relay when driving several motors with one inverter or when using a multi-pole motor. When using a thermal overload relay, set inverter constant L1-01 to 0 (motor protection selection: disabled). Additionally, for thermal overload relay, at 50Hz set the same rated current value as that described on the motor nameplate, or at 60Hz 1.1 times larger than the rated current value described on the motor nameplate.

## (g) Wiring Distance between Inverter and Motor

If the total wiring distance between inverter and motor is excessively long and the inverter carrier frequency (main transistor switching frequency) is high, harmonic leakage current from the cable will adversely affect the inverter and peripheral devices.

If the wiring distance between inverter and motor is long, reduce the inverter carrier frequency as described below. Carrier frequency can be set by constant C6-01.

Table 2 Wiring Distance between Inverter and Motor

Wiring Distance between Inverter and Motor	Up to 50m	Up to 100m	More than 100m
Carrier Frequency (Set value of constant C6-01)	15kHz or less (15.0)	10kHz or less (10.0)	5kHz or less (5.0)

## (3) Grounding

- Ground resistance  
200V class : 100Ω or less, 400 V class : 10Ω or less.
- Never ground the inverter in common with welding machines, motors, or other large-current electrical equipment. Run all the ground wires in a conduit separate from wires for large-current electrical equipment.
- Use the ground wires described in Table 5 or 6 and keep the length as short as possible.
- When using several inverter units side by side, ground the units as shown in Fig. 10, (a) or (b). Do not loop the ground wires as shown in (c).

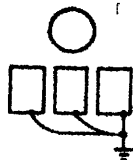

(a) Acceptable

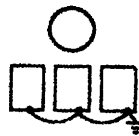

(b) Acceptable

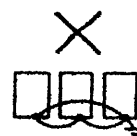

(c) Not Acceptable

Fig. 10 Grounding of Three Inverter Units

#### (4) Functions of Main Circuit Terminals

The following table outlines the functions of the main circuit terminals. Wire according to each terminal function.

Table 3 200V Class Terminal Functions

Models CIMR-L5A □	24P5	27P5, 2011	2015	2022 to 2045
Max Applicable Motor Output	4.5 kW	7.5, 11 kW	15 kW	22 to 45 kW
R (L1)	Main circuit input power supply			
S (L2)				
T (L3)				
U (T1)	Inverter output			
V (T2)				
W (T3)				
B1	Braking resistor unit	—		
B2				
⊖	<ul style="list-style-type: none"> <li>• DC reactor (⊕1 - ⊕2)</li> <li>• DC bus terminals (⊕1 - ⊖)</li> </ul>	<ul style="list-style-type: none"> <li>• DC reactor (⊕1 - ⊕2)</li> <li>• DC bus terminals (⊕1 - ⊖)</li> <li>• Braking unit (⊕3 - ⊖)</li> </ul>	<ul style="list-style-type: none"> <li>• DC bus terminals (⊕1 - ⊖)</li> <li>• Braking unit (⊕3 - ⊖)</li> </ul>	<ul style="list-style-type: none"> <li>• Braking unit (⊕3 - ⊖)</li> <li>(⊕1 and ⊕2 terminals not provided)</li> </ul>
⊕1				
⊕2				
⊕3	—			
r (ℓ1)	—		Cooling fan power supply	
s (ℓ2)				
⊕	Ground terminal (Ground resistance 100Ω or less)			
P0	Control power supply input (250 to 300 VDC) during battery operation			
No				

Note Models CIMR-L5A24P5 to -L5A2015 are not provided with P0 or No terminal block

Table 4 400V Class Terminal Functions

Models CIMR-L5A <input type="checkbox"/>	44P5 to 49P5	4013 to 4030	4037, 4045
Max Applicable Motor Output	4.5 to 9.5 kW	13 to 30 kW	37, 45 kW
R (L1)		Main circuit input power supply	
S (L2)			
T (L3)			
U (T1)		Inverter output	
V (T2)			
W (T3)			
B1	Braking resistor unit	—	
B2			
⊖	<ul style="list-style-type: none"> <li>• DC reactor (⊕1 - ⊕2)</li> <li>• DC bus terminals (⊕1 - ⊖)</li> </ul>	<ul style="list-style-type: none"> <li>• DC bus terminals (⊕1 - ⊖)</li> <li>• Braking unit (⊕3 - ⊖)</li> </ul>	<ul style="list-style-type: none"> <li>• Braking unit (⊕3 - ⊖)</li> <li>(⊕1 and ⊕2 terminals not provided)</li> </ul>
⊕1			
⊕2			
⊕3			
Δ (ℓ2)	—	Cooling fan power supply	—
r (ℓ1)			<ul style="list-style-type: none"> <li>• Cooling fan power supply (Control power supply)</li> <li>r (ℓ1) - Δ200 (ℓ2 200) 200 to 230 VAC input</li> <li>r (ℓ1) - Δ400 (ℓ2 400) 380 to 460 VAC input</li> </ul>
Δ 200			
Δ 400			
⊕	Ground terminal (Ground resistance 10Ω or less)		
Po	Control power supply input (500 to 600 VDC) during battery operation		
No			

Note Models CIMR-L5A44P5 to L5A4030 are not provided with Po or No terminal block

(5) Main Circuit Configuration

200V Class

CIMR-L5A24P5

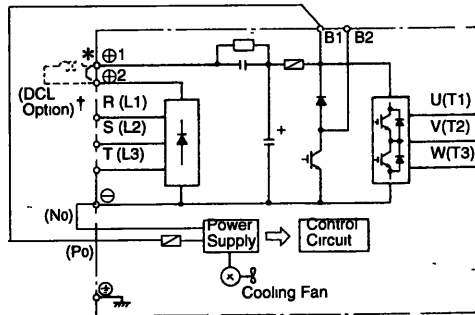

CIMR-L5A27P5, 2011

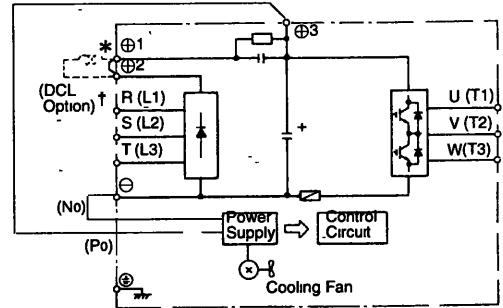

CIMR-L5A2015

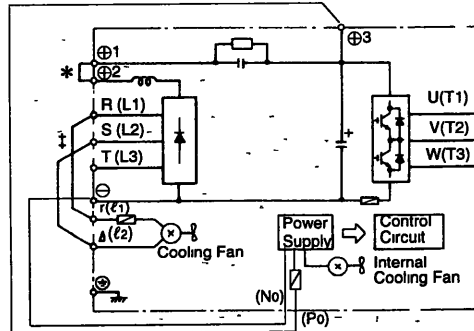

CIMR-L5A2022 to 2045

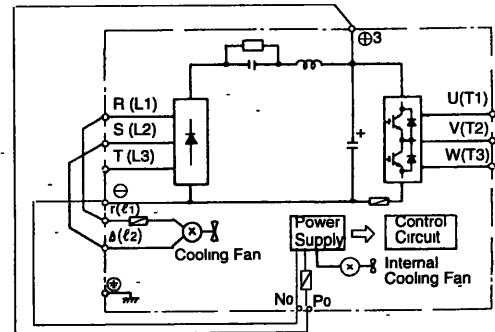

\* The wiring has been completed at the factory prior to shipping

† When installing a DC reactor (option) on models of 11kW or below, remove the short-circuit bar between ⊕1 and ⊕2 terminals and connect a DC reactor with the terminals

‡ The wiring has been completed at the factory prior to shipping When using main circuit power supply as DC input, remove the wirings of L1(R) - r (ℓ1) and L2(S) - Δ (ℓ2)



400V Class

CIMR-L5A44P5 to 49P5

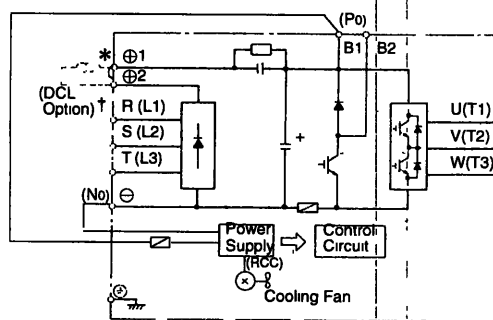

CIMR-L5A4013 to 4030

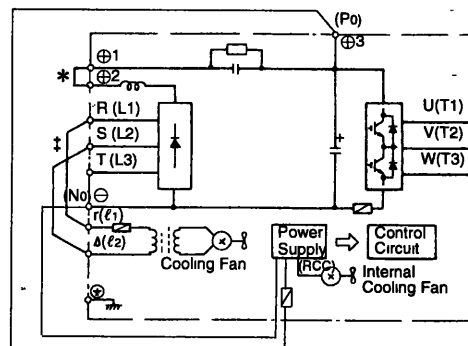

CIMR-L5A4037 to 4045

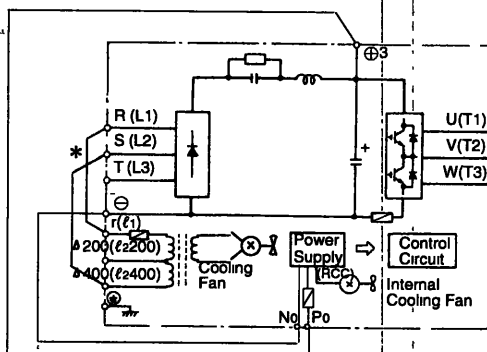

- \* The wiring has been completed at the factory prior to shipping
- † When installing a DC reactor (option) on models of 9.5 kW or below, remove the short-circuit bar between ⊕1 and ⊕2 terminals and connect a DC reactor with the terminals
- ‡ The wiring has been completed at the factory prior to shipping. When using main circuit power supply as DC input, remove the wirings of L1(R) - r(ℓ1) and L2(S) - Δ 400 (ℓ2 400)

(6) Parts Required for Wiring

Select wires or closed-loop connectors to be used for wiring from Tables 5, 6 and 7.

Table 5 200V Class Wire Size

Circuit	Model CIMR-□□	Terminal Symbol	Terminal Screw	Wire Size* mm <sup>2</sup>	Wire Type
Main	L5A24P5	R, S, T, ⊖, ⊕1, ⊕2, B1, B2, U, V, W	M5	8	Power cable 600V vinyl sheathed wire or equivalent
		⊕		5.5 - 8	
	L5A27P5	R, S, T, ⊖, ⊕1, ⊕2, ⊕3, U, V, W	M6	22	
		⊕		8	
	L5A2011	R, S, T, ⊖, ⊕1, ⊕2, ⊕3, U, V, W	M8	30	
		⊕	M6	8	
	L5A2015	R, S, T, ⊖, ⊕1, ⊕2, ⊕3, U, V, W	M8	38	
		⊕		14	
		r(ℓ <sub>1</sub> ), Δ(ℓ <sub>2</sub> )	M4	0.5 - 5.5	
	L5A2022	R, S, T, U, V, W	M10	100	
		⊖, ⊕3	M8	—	
		⊕	M8	22	
		r(ℓ <sub>1</sub> ), Δ(ℓ <sub>2</sub> ), P0, N0	M4	0.5 - 5.5	
	L5A2030	R, S, T, U, V, W	M10	60 × 2P	
		⊖, ⊕3	M8	—	
		⊕	M8	22	
		r(ℓ <sub>1</sub> ), Δ(ℓ <sub>2</sub> ), P0, N0	M4	0.5 - 5.5	
	L5A2037	R, S, T, U, V, W	M10	60 × 2P	
		⊖, ⊕3	M8	—	
		⊕	M8	30	
r(ℓ <sub>1</sub> ), Δ(ℓ <sub>2</sub> ), P0, N0		M4	0.5 - 5.5		
L5A2045	R, S, T, U, V, W	M12	100 × 2P		
	⊖, ⊕3	M8	—		
	⊕	M8	50		
	r(ℓ <sub>1</sub> ), Δ(ℓ <sub>2</sub> ), P0, N0	M4	0.5 - 5.5		
Control	Common to all models	1 - 43	—	0.5 - 1.25	Twisted shielded wire
		E	M3.5	0.5 - 2	

\* Wire size is determined using 75°C temperature-rated copper wire

When connecting a braking resistor unit or a braking unit, select wire size referring to the instructions of braking resistor unit and braking unit (manual No. TOE-C726-2)

Table 6 400V Class Wire Size

Circuit	Model CIMR-□□□	Terminal Symbol	Terminal Screw	Wire Size* mm <sup>2</sup>	Wire Type
Main	L5A44P5	R, S, T, ⊖, ⊕1; ⊕2, B1, B2, U, V, W	M5	5.5	Power cable 600V vinyl sheathed wire or equivalent
		⊕			
	L5A47P5	R, S, T, ⊖, ⊕1; ⊕2, B1, B2, U, V, W	M5	8 - 14	
		⊕	M6	8	
	L5A49P5	R, S, T, ⊖, ⊕1; ⊕2, B1, B2, U, V, W	M5	8 - 14	
		⊕	M6	8	
	L5A4013	R, S, T, ⊖, ⊕1; ⊕2, ⊕3, U, V, W	M6	14	
		⊕	M8	8	
		r(ℓ <sub>1</sub> ), Δ(ℓ <sub>2</sub> )	M4	0.5 - 5.5	
		L5A4015	R, S, T, ⊖, ⊕1; ⊕2, ⊕3, U, V, W	M6	
	⊕		M8	8	
		r(ℓ <sub>1</sub> ), Δ(ℓ <sub>2</sub> )	M4	0.5 - 5.5	
		L5A4022	R, S, T, ⊖, ⊕1; ⊕2, ⊕3, U, V, W	M8	
	⊕		8		
		r(ℓ <sub>1</sub> ), Δ(ℓ <sub>2</sub> )	M4	0.5 - 5.5	
		L5A4030	R, S, T, ⊖, ⊕1; ⊕2, ⊕3, U, V, W	M8	
⊕	14				
	r(ℓ <sub>1</sub> ), Δ(ℓ <sub>2</sub> )	M4	0.5 - 5.5		
	L5A4037	R, S, T, U, V, W	M10	100	
⊖, ⊕3		M8	—		
⊕			22		
L5A4045	r(ℓ <sub>1</sub> ), Δ 200(ℓ <sub>2</sub> 200), Δ 400(ℓ <sub>2</sub> 400), P0, No	M4	0.5 - 5.5		
	R, S, T, U, V, W	M10	60 × 2P		
	⊖, ⊕3	M8	—		
	⊕		22		
	r(ℓ <sub>1</sub> ), Δ 200(ℓ <sub>2</sub> 200), Δ 400(ℓ <sub>2</sub> 400), P0, No	M4	0.5 - 5.5		
Control	Common to all models	I - 43	—	0.5 - 1.25	Twisted shielded wire
		E	M3.5	0.5 - 2	

\* Wire size is determined using 75°C temperature-rated copper wire

When connecting a braking resistor unit or a braking unit, select wire size referring to the instructions of braking resistor unit and braking unit (manual No. TOE-C726-2)

Table 7 Closed-Loop Connectors

Wire Size mm <sup>2</sup>	Terminal Screw	Closed-Loop Connectors
0.5	M3.5	1.25 - 3.5
	M4	1.25 - 4
0.75	M3.5	1.25 - 3.5
	M4	1.25 - 4
1.25	M3.5	1.25 - 3.5
	M4	1.25 - 4
2	M3.5	2 - 3.5
	M4	2 - 4
	M5	2 - 5
	M6	2 - 6
	M8	2 - 8
3.5 / 5.5	M4	5.5 - 4
	M5	5.5 - 5
	M6	5.5 - 6
	M8	5.5 - 8
8	M5	8 - 5
	M6	8 - 6
	M8	8 - 8
14	M6	14 - 6
	M8	14 - 8
22	M6	22 - 6
	M8	22 - 8
30 / 38	M8	38 - 8
50 / 60	M8	60 - 8
	M10	60 - 10
80	M10	80 - 10
100		100 - 10
100	M12	100 - 12
150		150 - 12
200		200 - 12
325		M12 × 2
	M16	325 - 16

**NOTE**

When determining wire size, consider voltage drop. Select a wire size so that voltage drop will be less than 2% of the normal rated voltage. Voltage drop is calculated by the following equation:

Phase-to-phase voltage drop (V)

$$= \sqrt{3} \times \text{wire resistance } (\Omega/\text{km}) \times \text{wiring distance (m)} \times \text{current (A)} \times 10^{-3}$$

### 3.3 WIRING THE CONTROL CIRCUIT

The following table outlines the functions of the control circuit terminals. Wire according to each terminal function

#### (1) Functions of Control Circuit Terminals

Table 8 Control Circuit Terminals

Classification	Terminal	Signal Function	Description	Signal Level	
Sequence Input Signal	1	Forward run/stop	Forward run when closed, stop when open	Photo-coupler insulation Input +24 VDC 8 mA	
	2	Reverse run/stop	Reverse run when closed, stop when open		
	3	External fault input	Fault when closed, normal state when open		
	4	Fault reset input	Reset when closed		
	5	Master/Auxiliary change (Multi-step speed reference 1)	Auxiliary frequency reference when closed		
	6	Multi-step speed reference 2	Effective when closed		
	7	Jog reference	Jog run when closed		
	8	External baseblock	Inv output stop when closed		
	11	0V for sequence input			
	35	Sequence input internal common			
	36	+24V for sequence input			
Analog Input Signal	15	+15 V Power supply output	For analog command +15 V power supply	+15 V (Allowable current 20 mA max)	
	33	-15 V Power supply output	For analog command -15 V power supply	-15 V (Allowable current 20 mA max)	
	13	Master frequency reference	-10 to +10 V/-100% to +100% 0 to +10 V/100%	-10 to +10 V (20 kΩ), 0 to +10 V (20 kΩ)	
	14		4 to 20 mA/100%, -10 to +10 V/-100% to +100%, 0 to +10 V/100%	4 to 20mA (250Ω)	
	16	Multi-function analog input	-10 to +10V/-100% to +100% 0 to +10 V/100%	Auxiliary analog input (H3-05)	-10 to +10V (20kΩ), 0 to +10V (20kΩ)
	17	Common terminal for control circuit		0 V	
Sequence Output Signal	9	During running (NO contact)	Closed when running	Multi-function output	Dry contact Contact capacity 250 VAC 1 A or less 30 VDC 1 A or less
	10				
	25				
	27	Zero speed detection	Closed at zero-speed level (b2-01) or below		Open collector output 48 V 50 mA or less *
	26	Speed agree detection	Closed when the freq reaches to ±2 Hz of set freq		
	37	Speed agree detection	Closed when the freq reaches to ±2 Hz of set freq		
	18	Fault contact output (NO/NC contact)	Fault when closed between terminals 18 and 20 Fault when open between terminals 19 and 20		Dry contact Contact capacity 250 VAC 1 A or less 30 VDC 1 A or less
19					
20					
Analog Output Signal	21	Frequency meter output	0 to +10 V/100% freq	Multi-function analog monitor 1 (H4-01,H4-02)	0 to ±10 V Max ±5% 2 mA or less
	22	Common			
	23	Current monitor	5 V/inverter rated current	Multi-function analog monitor 2 (H4-04,H4-05)	
Serial Communication (RS-422/485)	40	R+ Receiver (RS-422) R+/S+ Receiver/Driver (RS-485)	RS-422 or RS-485 can be selected by the dip switch on the control PC board		
	41	R- Receiver (RS-422) R-/S- Receiver/Driver (RS-485)			
	42	S+ Driver (RS-422) R+/S+ Receiver/Driver (RS-485)			
	43	S- Driver (RS-422) R-/S- Receiver/Driver (RS-485)			

\* When an inductive load such as a relay coil is driven, insert a fly-wheel diode as shown in the following figure

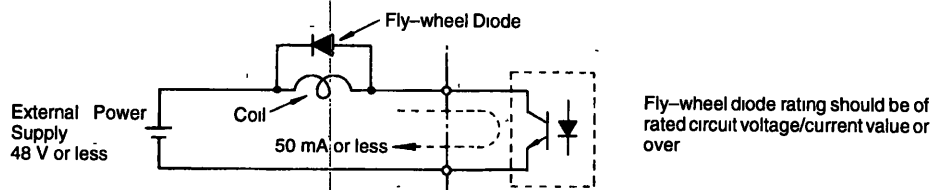

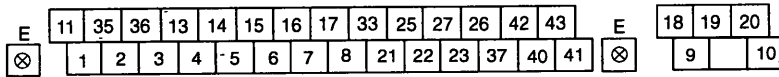

Fig. 11 Control Circuit Terminal Arrangement

(2) Precautions on Control Circuit Wiring

- Separate control circuit wires 1 to 43 from main circuit wires L1, L2, L3, B1, B2, U, V, W, ⊖, ⊕1, ⊕2, ⊕3 and other power cables to prevent erroneous operation caused by noise interference
- Separate the wiring of control circuit terminals 9, 10, 18, 19 and 20 (contact output) from those of terminals 1 to 8, 21, 22, 23, 25, 26, 27, 33 and 11 to 17, 40 to 43
- Use twisted shielded or twisted-pair shielded wire for the control circuit line and connect the shielded sheath to the inverter terminal 12. See Fig. 12. Wiring distance should be less than 50 m.

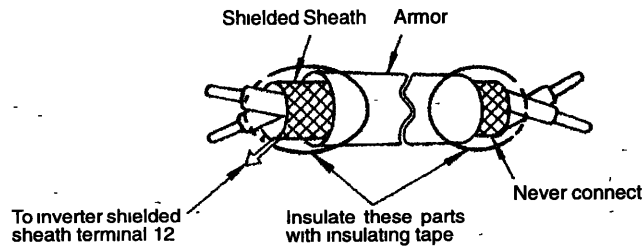

Fig. 12 Shielded Wire Termination

### 3.4 WIRING INSPECTION

After completing of installation and wiring, check for the following items. Never use control circuit buzzer check.

- Wiring is proper.
- Wire clippings or screws are not left in the unit.
- Screws are securely tightened.
- Bare wire in the terminal does not contact other terminals.

## 4 SETTING OPERATION CONDITIONS

### ⚠ CAUTION

- Never connect the motor to the load (machines or equipment) when conducting auto-tuning. Motor rotation may cause injury or equipment damage as well as incorrect motor constant settings.

Before operating the motor by the VS-676GL5, operation conditions must be set by using the digital operator. This chapter describes the digital operator functions, mode selection/functions and constants setting in each mode.

### 4.1 DIGITAL OPERATOR KEY DESCRIPTION

When the main circuit power supply is turned ON, the digital operator display is as shown below. The following describes the functions of the digital operator keys

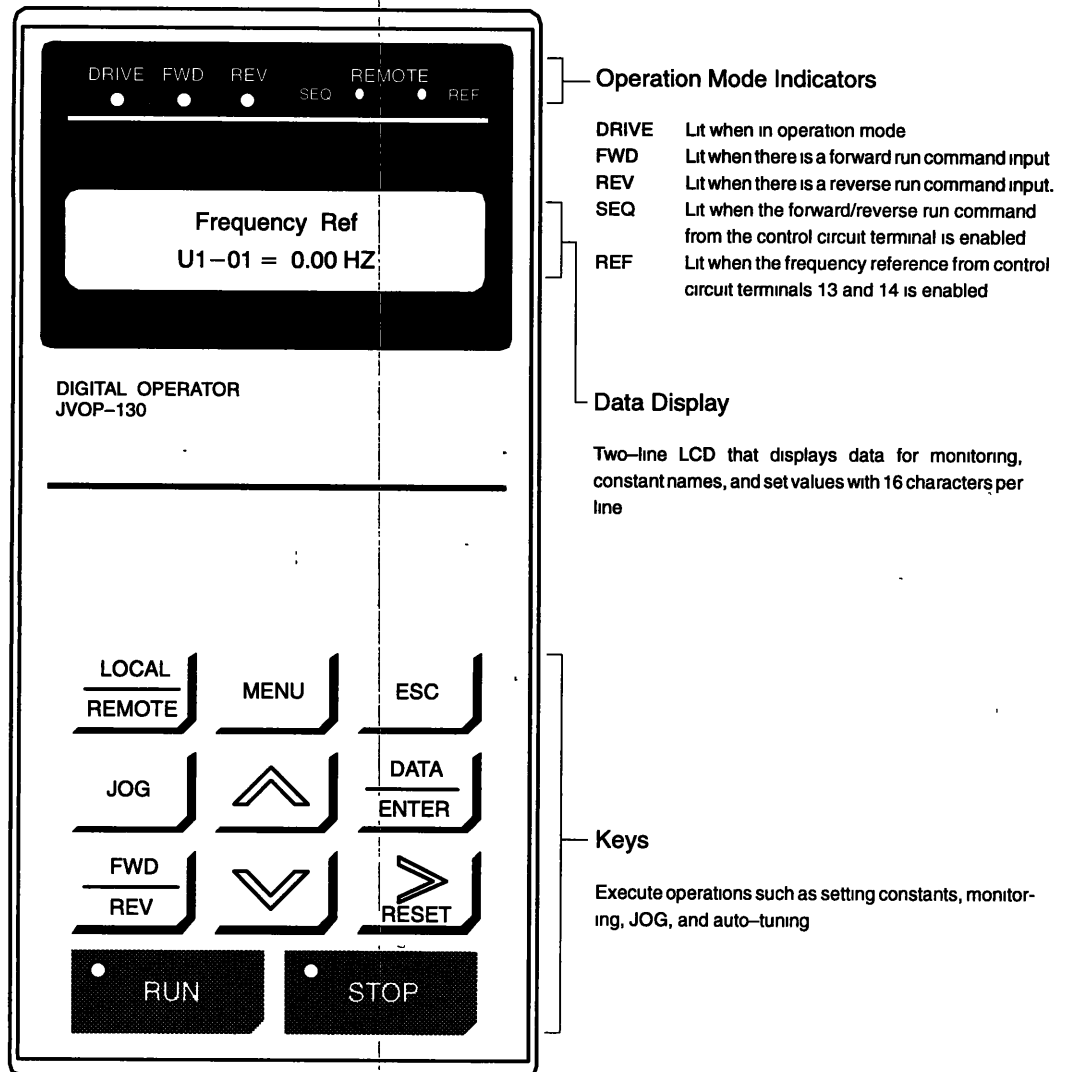













Fig. 13 Digital Operator Key Description

Key	Name	Function
	Operation Mode Selection Key	Switches between digital operator and constant setting (run command and frequency reference) This key can be enabled or disabled with a constant setting (o2-01)
	Menu Key	Displays each mode
	Escape Key	Returns to the status before the enter key is depressed
	Jog Key	Enables jog operation when the VS-676GL5 is in operation with the digital operator
	Forward/Reverse Rotation Selection Key	Selects the rotation direction of the motor when the VS-676GL5 is in operation with the digital operator
	Reset/Digit Selection Key	Selects digits for constant settings Also acts as the reset key when an fault has occurred
	Increment Key	Selects modes, groups, functions, constant names, and set values This key increases numbers when depressed
	Decrement Key	Selects modes, groups, functions, constant names, and set values This key decreases numbers when depressed
	Enter Key	Enters, modes, functions, constants, and set values after they are set
	Run Key	Starts the VS-676GL5 running when the VS-676GL5 is in operation with the digital operator
	Stop Key	Stops the VS-676GL5 running This key can be enabled or disabled with a constant setting (o2-02) in operation with the control circuit terminal

RUN or STOP LED changes in accordance with the following operations.

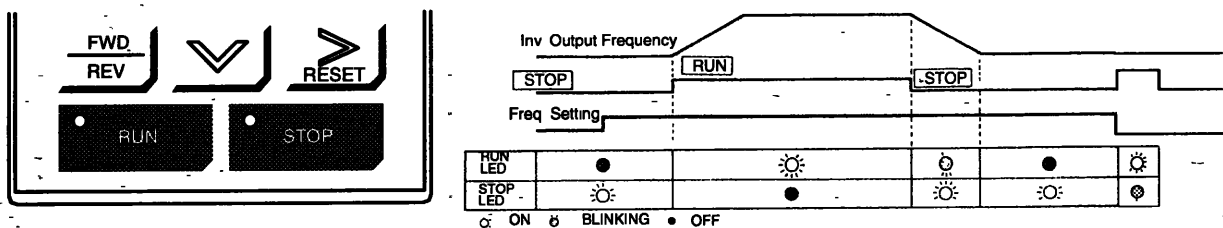

Fig. 14 Run, Stop LED Display



## 4.2 DIGITAL OPERATOR MODE

This section describes the monitoring mode, mode switching, and constant reading/setting of the VS-676GL5.

### (1) Inverter Modes

The VS-676GL5 organizes the constants into function groups for easier constant setting and reading.

The VS-676GL5 is equipped with 5 modes as shown in the following table.

Mode	Primary Functions
Operation Mode	The inverter can be run in this mode Use this mode when monitoring values such as frequency references or output current, displaying fault information, or displaying the fault history
Initialize Mode	Use this mode when selecting the language displayed on the digital operator, selecting the access level for setting/reading constants, selecting the control method, or initializing the constants
Programming Mode	Use this mode when setting/reading the constants required for operation. The programming-mode functions are subdivided into the following groups <ul style="list-style-type: none"> <li>• Application    Operation mode selection, DC braking, speed search, etc</li> <li>• Tuning        Acceleration/deceleration times, S-curve characteristics, carrier frequencies, etc</li> <li>• Reference    Settings related to frequency control</li> <li>• Motor        V/f characteristics and motor constants</li> <li>• Option       Settings for option cards</li> <li>• Terminal    Settings for sequential I/O and analog I/O</li> <li>• Protection   Settings for the motor and inverter protection functions</li> <li>• Operator    Selects the digital operator's display and key functions</li> <li>• Elevator    Elevator function constants</li> </ul>
Auto-tuning Mode	Use this mode when running a motor with unknown motor constants. The motor constants are calculated and set automatically
Modified Constants Mode	Use this mode to set/read constants that have been changed from their factory-set values

## (2) Switching Modes

The inverter enters the operation mode by depressing [MENU] key. Then, the mode is changed by depressing [^] or [v] key. Depress [DATA/ENTER] key to read or set the constants in each mode.

Depress [ESC] key to return to the mode display from constant display.

Depress [DATA/ENTER] key twice to display "Entry Accepted".

Depress [ESC] key to return to the mode display. These are the basic operation steps

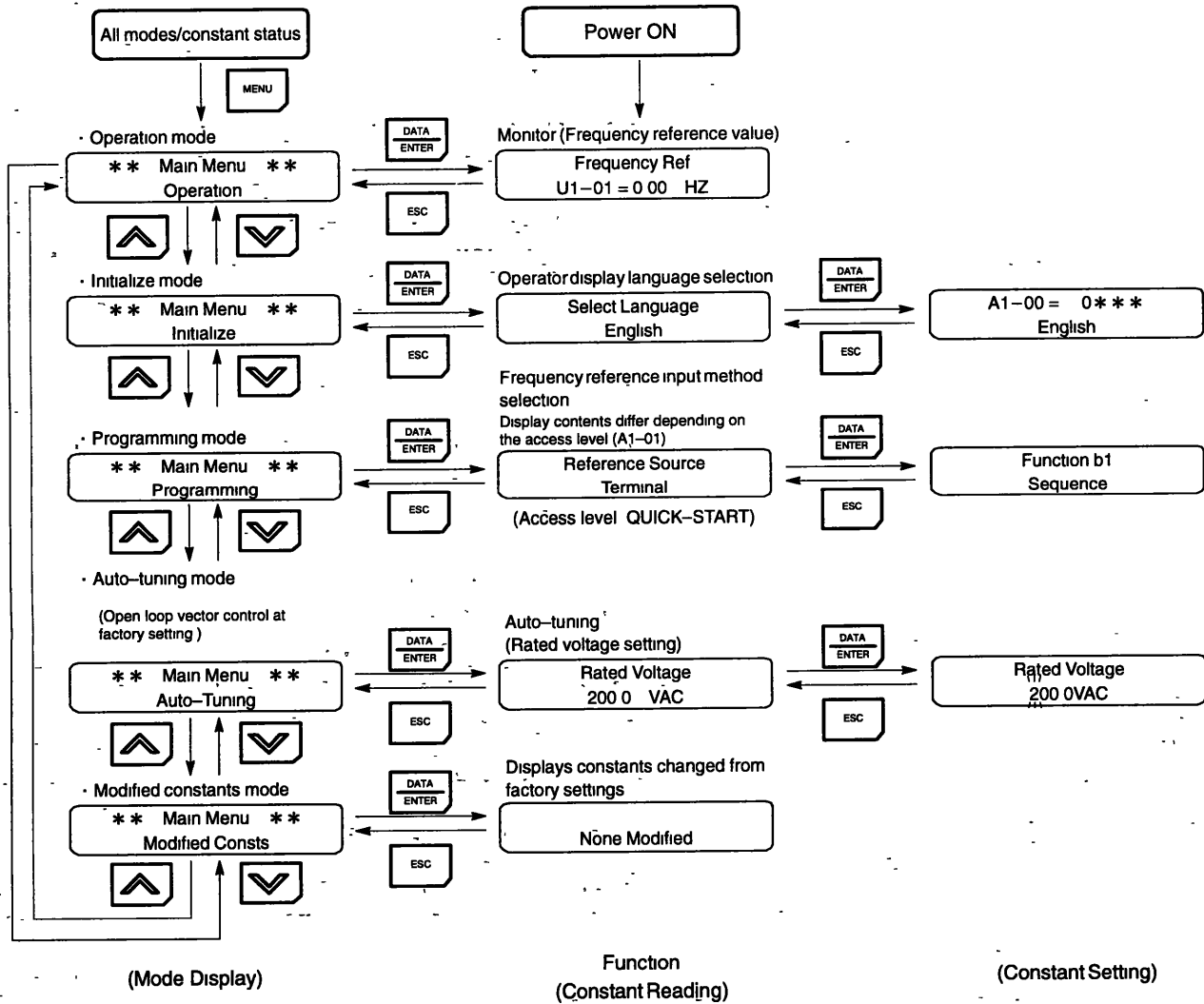

## (3) Constant Access Level











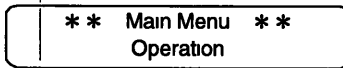

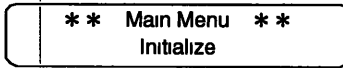
The VS-676GL5 has three access levels which divide the various constants based according to their usage, as shown below. The access level determines which constants can be set or displayed.

QUICK-START	Allows reading/setting of constants required for test runs (Factory setting)
BASIC	Allows reading/setting of general-purpose constants
ADVANCED	Allows reading/setting of all constants

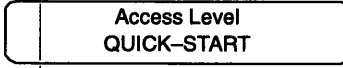
The constants that can be read/set and the display class differ depending on the access level. Set the access level in initialize mode with constant A1-01.

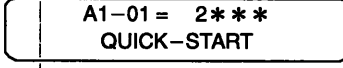
## (a) Changing the Access Level from QUICK-START to BASIC

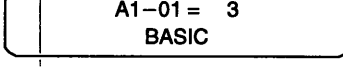
Constant access level is set at QUICK-START prior to shipment. Change the level to BASIC.

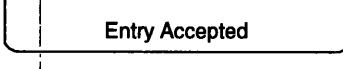
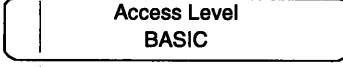
Step	Key Sequence	Digital Operator Display	Remarks
①			
②			
③			
④			
⑤			
⑥			
⑦			
			After approx 3 seconds, the operator display is as shown on the left

As shown above, QUICK-START has been changed to BASIC.

The following diagram shows this procedure in flowchart format.

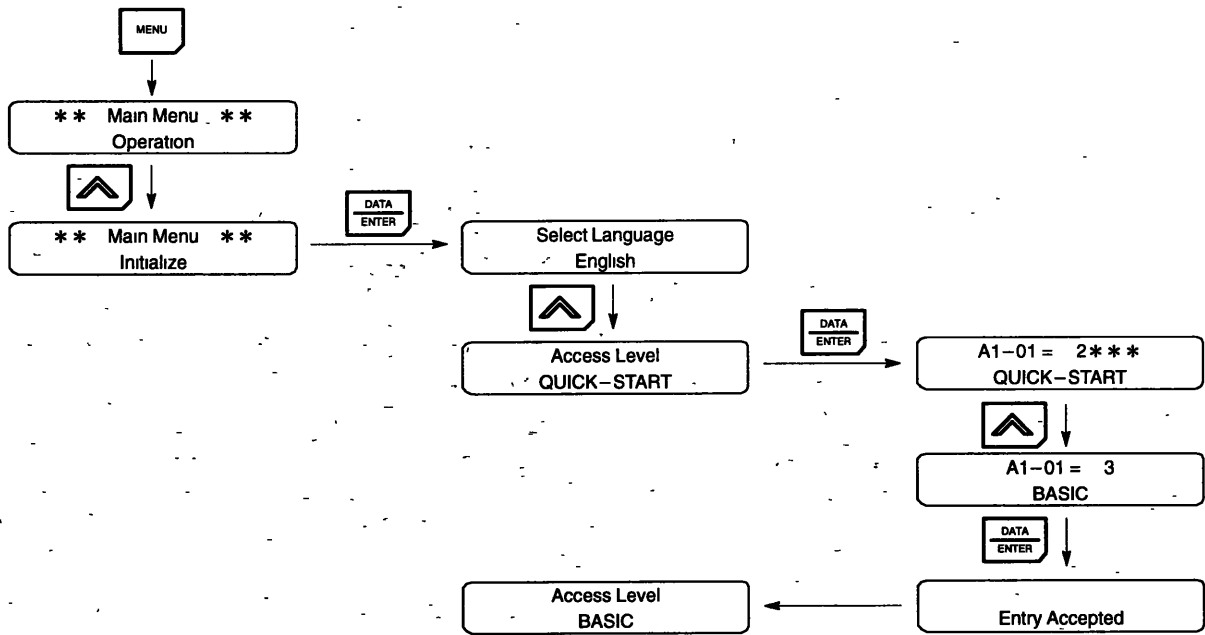

**(b) Setting Constants in Each Access Level**

The displays in programming mode differ for each access level. (There is no difference in other modes.)

This section provides the procedure to change the acceleration time to 20 s in each access level.

If the new constant setting is not written to the inverter (by depressing the [DATA/ENTER] key) within one minute after starting the procedure, the display automatically returns to the former constant setting. In this case, the procedure must be repeated.



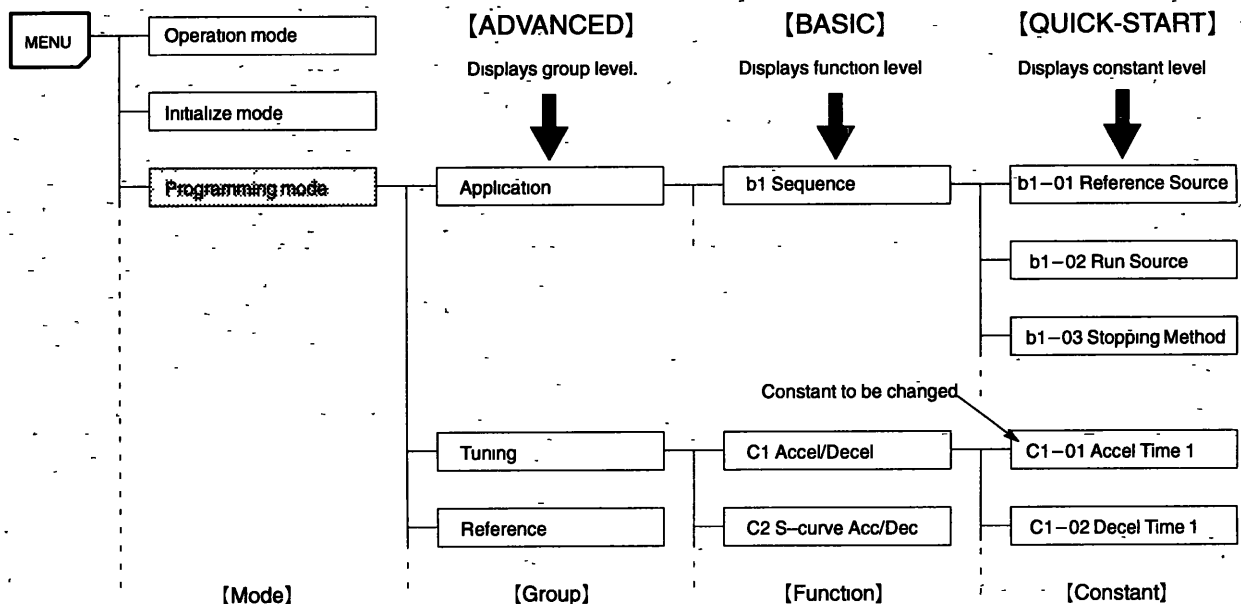







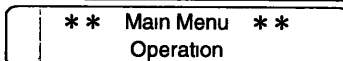

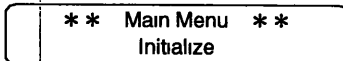
**Constant Setting Levels (Partial)**

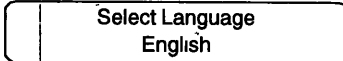

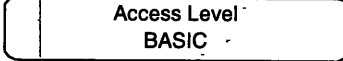
**[Example] Setting the Constants in QUICK-START access level**

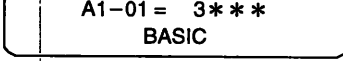

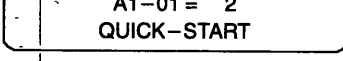

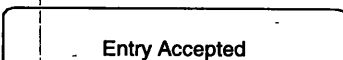
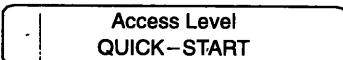





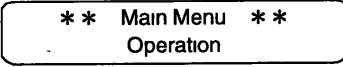



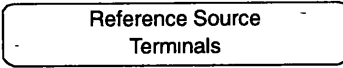

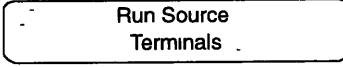

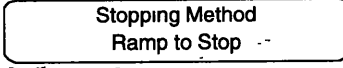
The constant setting level is displayed when the [DATA/ENTER] key is depressed at the programming mode display.

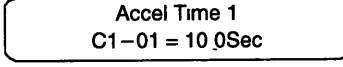
Since QUICK-START has been changed to BASIC, follow the procedures below to return to QUICK-START. (Steps 1 to 7)

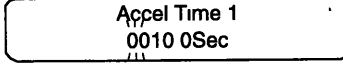
Step	Key Sequence	Digital Operator Display	Remarks
①			
②			
③			
④			
⑤			
⑥	 Depress 3 times		
⑦			
			After approx 3 seconds, the operator display is as shown on the left

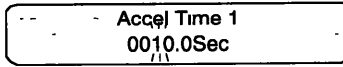
QUICK-START level has been set.

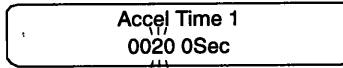
Set the acceleration time to 20 seconds

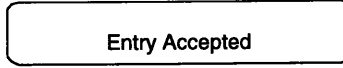
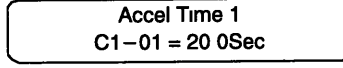
Step	Key Sequence	Digital Operator Display	Remarks
⑧			
⑨	 Depress twice		
⑩			Changed to constant setting level
⑪			
⑫			
⑬			
⑭			The value in blinking digit can be changed
⑮	 Depress twice		Blinking digit moves 2 places down
⑯			Changes 1 to 2
⑰		  	After approx 3 seconds, the operator display is as shown on the left

The acceleration time has been set to 20 seconds.

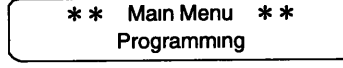
Step	Key Sequence	Digital Operator Display	Remarks
⑱			











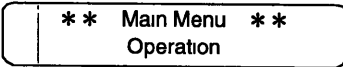



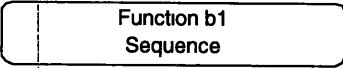

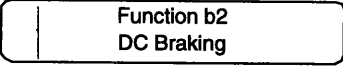

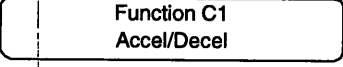

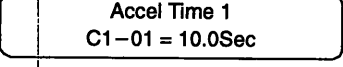
Returns to programming mode display.

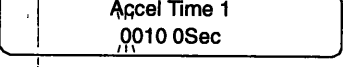
**[Example] Setting the Constants in BASIC access level**

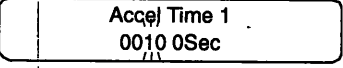
The function level is displayed when the [DATA/ENTER] key is depressed at the programming mode display.

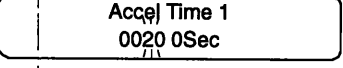
Since the access level has been changed to QUICK-START, follow the procedures below to return to BASIC. Refer to "Changing the Access Level from QUICK-START to BASIC".

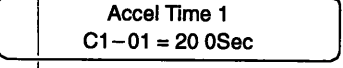

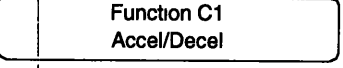













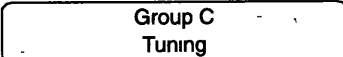

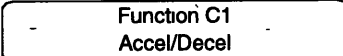

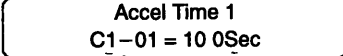
Set the accel time to 20 0 seconds in the BASIC level.

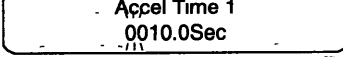
Step	Key Sequence	Digital Operator Display	Remarks
①			
②	 Depress twice		
③			Changed to constant reading (function) level
④			
⑤			
⑥			Changed to constant setting level
⑦			The value in blinking digit can be changed
⑧	 Depress twice		Blinking digit moves 2 places down
⑨			Changes 1 to 2
⑩			Writes-in the new setting
			The operator display is as shown on the left
⑪			

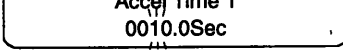
Returns to "Function C1 Accel/Decel" display.

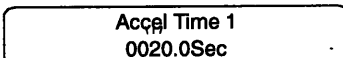
**[Example] Setting the Constants in ADVANCED access level**

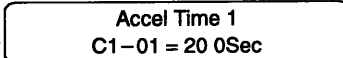
Change the access level to ADVANCED. The group level is displayed when the [DATA/ENTER] key is depressed at the programming mode display

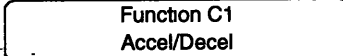
Step	Key Sequence	Digital Operator Display	Remarks
①			
②	 Depress twice		
③			
④			
⑤			Changed to constant reading (function) level
⑥			
⑦			The value in blinking digit can be changed
⑧	 Depress twice		Blinking digit moves 2 places down
⑨			Changes 1 to 2
⑩			Writes-in the new setting
			After few seconds, the operator display is as shown on the left
⑪			

The constant setting in ADVANCED level (accel time change from 10.0 seconds to 20.0 seconds) has been completed.



(4) Operation Mode

The VS-676GL5 can be operated in the operation mode.

Some constants cannot be changed while the VS-676GL5 is running. Refer to "Monitor Constants List" for details.

In the operation mode, monitor displays such as frequency reference, output frequency, output current, output voltage, and fault contents/fault history displays are provided.

NOTE

To operate the VS-676GL5, depress [MENU] key to change to the operation mode. Then depress [DATA/ENTER] key to enter status monitor mode. Operation commands will not be received under any other display status. When the status monitor mode is entered, it is possible to move to other modes.

(a) Operations in Operation Mode

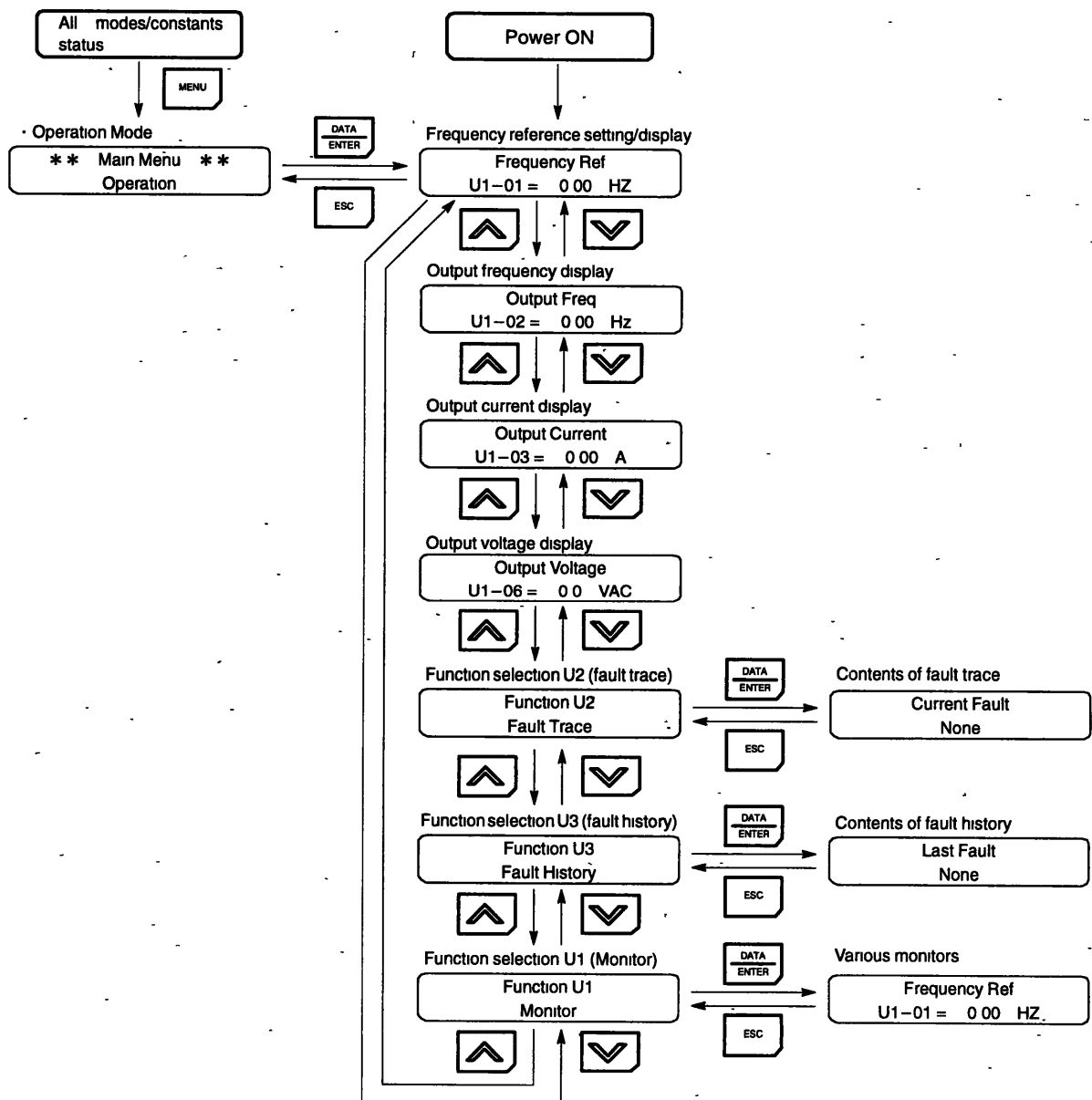

(b) Conditions for Monitoring

The following tables show the items that can be monitored in operation mode. The table's "Valid access levels" column indicates whether an item can be monitored in a particular access level and control method. The codes in this column have the following meanings

Q	These items can be monitored in all access levels (QUICK-START, BASIC, and ADVANCED)
B	These items can be monitored in the BASIC and ADVANCED access levels
A	These items can be monitored in the ADVANCED access level only
X	These items cannot be monitored in the control method shown

The output signal levels for multi-function analog outputs shown in the table are for a gain of 100.0 and a bias of 0.00.

Table 9 Monitoring Constants in Operation Mode

Digital Operator Function Display	Constant No.	Name	Function	Output Signal Levels for Multi-function Analog Outputs	Min Units	Valid Access Levels	
		Digital Operator Display				Open Loop Vector	Flux Vector
Monitor	U1-01	Frequency reference	Monitors/sets the frequency reference value	10V Max Frequency (0 to ±10V possible)	0.01 Hz	Q	Q
		Frequency Ref	The display units can be set with constant 01-03				
	U1-02	Output frequency	Monitors the output frequency	10V Max Frequency (0 to ±10V possible)	0.01 Hz	Q	Q
		Output Freq	The display units can be set with constant 01-03				
	U1-03	Output current	Monitors the output current	10V Inverter rated current (0 to +10V output)	0.1 A	Q	Q
		Output Current					
	U1-04	Control method	Shows which control method is set	Can't be output	-	Q	Q
		Control Method					
	U1-05	Motor speed	Monitors the motor speed	10V Max frequency (0 to ±10V possible)	0.01 Hz	Q	Q
		Motor Speed					
	U1-06	Output voltage	Monitors the inverter's internal output voltage reference value	10V 200 (400) VAC (0 to +10V output)	0.1 V	Q	Q
		Output Voltage					
	U1-07	DC bus voltage	Monitors the DC bus voltage of the inverter's internal-main circuit	10V 400 (800) VDC (0 to +10V output)	1 V	Q	Q
		DC Bus Voltage					
U1-08	Output power	Monitors the output power (This is an internally detected value)	10V Max motor capacity ((0 to ±10V possible)	0.1 kW	Q	Q	
	Output kWatts						
U1-09	Torque reference	Monitors the internal torque reference value	10V Motor rated torque (0 to ±10V possible)	0.1 %	Q	Q	
	Torque Reference						
U1-10	Input terminal status	Shows the ON/OFF status of inputs	Can't be output	-	Q	Q	
	Input Term Sts	<p>U1-10 = 00000000</p>					

Digital Operator Function Display	Constant No	Name	Function	Output Signal Levels for Multi-function Analog Outputs	Min. Units	Valid Access Levels	
		Digital Operator Display				Open Loop Vector	Flux Vector
Monitor	U1-11	Output terminal status	Shows the ON/OFF status of outputs 	Can't be output	—	Q	Q
		Output Term Sts					
	U1-12	Operation status	Shows the inverter's operating status 	Can't be output	—	Q	Q
		Int Ctl Sts 1					
	U1-13	Cumulative operation time	Monitors the inverter's cumulative operation time The initial value and running/power-ON time selection can be set with constant o2-07 and o2-08	Can't be output	1 hour	Q	Q
		Elapsed Time					
	U1-14	Software No	Manufacturer's ID number	Can't be output	—	Q	Q
		FLASH ID					
	U1-15	Terminal 13 input voltage level	Monitors the input voltage of the frequency reference (voltage) An input of 10V corresponds to 100%	10V 100% (10V) (0 to ±10V possible)	0.1 %	B	B
		Term 13 Level					
	U1-16	Terminal 14 input current level	Monitors the input current of the frequency reference (current) An input of 20mA corresponds to 100%	10V 100% (20mA) (0 to +10V output)	0.1 %	B	B
		Term 14 Level					
	U1-17	Terminal 16 input voltage level	Monitors the input voltage of the multi-function analog input An input of 10V corresponds to 100%	10V 100% (10V) (0 to ±10V possible)	0.1 %	B	B
		Term 16 Level					
	U1-18	Motor secondary current (Iq)	Monitors the calculated value of the motor's secondary current (Iq) The motor's rated current corresponds to 100%	10V Motor rated current (0 to +10V output)	0.1 %	B	B
		Mot SEC Current					
	U1-19	Motor exciting current (Id)	Monitors the calculated value of the motor's exciting current (Id) The motor's rated current corresponds to 100%	10V Motor rated current (0 to +10V output)	0.1 %	B	B
		Mot EXC Current					
	U1-20	Output frequency after soft-start	Monitors the output frequency after a soft start The display shows the frequency without the correction from compensation functions such as slip compensation	10V Max frequency (0 to ±10V possible)	0.01 Hz	A	A
		SFS Output					
	U1-21	ASR input	Monitors the input to the speed control loop The max frequency corresponds to 100%	10V Max frequency (0 to ±10V possible)	0.01 %	×	A
ASR Input							

Digital Operator Function Display	Constant No	Name	Function	Output Signal Levels for Multi-function Analog Outputs	Min Units	Valid Access Levels		
		Digital Operator Display				Open Loop Vector	Flux Vector	
Monitor	U1-22	ASR output	Monitors the output from the speed control loop The motor's rated current corresponds to 100%	10V Motor rated current (0 to ±10V possible)	0.01 %	×	A	
		ASR Output						
	U1-25	DI-16H2 input status	Monitors the command value from a DI-16H2 digital reference card	Can't be output	—	—	A	A
		DI-16 Reference	The value will be displayed in binary or BCD depending on constant F3-01					
	U1-26	Output voltage reference (Vq)	Monitors the inverter's internal voltage reference value for the motor's secondary current control	10V 200 (400) VAC (0 to ±10V possible)	0.1 V	—	A	A
		Voltage Ref (Vq)						
	U1-27	Output voltage reference (Vd)	Monitors the inverter's internal voltage reference value for the motor's exciting current control	10V 200 (400) VAC (0 to ±10V possible)	0.1 V	—	A	A
		Voltage Ref Vd						
	U1-28	Software No.(CPU)	Manufacturer's CPU software number	Can't be output	0.1 V	—	A	A
		CPU ID						
	U1-32	ACR output of q axis	Monitors current control output value for motor secondary current	10V 100%	0.1 %	—	A	A
		ACR(q) Output						
	U1-33	ACR output of d axis	Monitors current control output value for motor exciting current	10V 100%	0.1 %	—	A	A
		ACR(d) Output						
U1-34	OPE error constant	Displays first the constant No detecting OPE error	Can't be output	—	—	A	A	
	OPE Detected							

Digital Operator Function Display	Con-stant No	Name	Function	Output Signal Levels for Multi-function Analog Outputs	Min Units	Valid Access Levels																							
		Digital Operator Display				Open Loop Vector	Flux Vector																						
Fault Trace *	U2-01	Current fault	Information on the current fault.	Can't be output	-	Q	Q																						
		Current Fault																											
	U2-02	Last fault	Information on the last fault			-	-	Q	Q																				
		Last Fault																											
	U2-03	Frequency reference at fault	Frequency reference value when the "last fault" occurred					-	-	Q	Q																		
		Frequency Ref																											
	U2-04	Output frequency at fault	Output frequency when the "last fault" occurred							-	-	Q	Q																
		Output Freq																											
	U2-05	Output current at fault	Output current when the "last fault" occurred									-	-	Q	Q														
		Output Current																											
	U2-06	Motor speed at fault	Motor speed when the "last fault" occurred											-	-	Q	Q												
		Motor Speed																											
	U2-07	Output voltage reference at fault	Output voltage when the "last fault" occurred													-	-	Q	Q										
		Output Voltage																											
	U2-08	DC bus voltage at fault	The main circuit DC voltage when the "last fault" occurred															-	-	Q	Q								
		DC Bus Voltage																											
	U2-09	Output power at fault	Output power when the "last fault" occurred																	-	-	Q	Q						
		Output kWatts																											
	U2-10	Torque reference at fault	Torque reference when the "last fault" occurred (Rated torque = 100%)																			-	-	Q	Q				
		Torque Reference																											
	U2-11	Input terminal status at fault	Input terminal status when the "last fault" occurred (Same format as U1-10)																					-	-	Q	Q		
		Input Term Sts																											
	U2-12	Output terminal status at fault	Output terminal status when the "last fault" occurred (Same format as U1-11)																							-	-	Q	Q
		Output Term Sts																											
U2-13	Operation status at fault	Inverter operating status when the "last fault" occurred (Same format as U1-12)	-	-	Q																							Q	
	Inverter Status																												Inverter operating status when the "last fault" occurred (Same format as U1-12)
U2-14	Cumulative operation time at fault	Cumulative operation time when the "last fault" occurred			-	-	Q																					Q	
	Elapsed time																												

\* When the faults of CPF00, 01, 02, 03, UV1 and UV2 occur, fault trace is not performed

Digital Operator Function Display	Constant No	Name	Function	Output Signal Levels for Multi-function Analog Outputs	Min Units	Valid Access Levels		
		Digital Operator Display				Open Loop Vector	Flux Vector	
Fault History *	U3-01	Most recent fault	Information on the last fault	Can't be output	-	Q	Q	
		Last Fault						
	U3-02	Second most recent fault	Information on the 2nd to last fault					
		Fault Message 2						
	U3-03	Third most recent fault	Information on the 3rd to last fault					
		Fault Message 3						
	U3-04	Fourth/oldest fault	Information on the oldest fault					
		Fault Message 4						
	U3-05	Cumulative operation time at fault	Cumulative operation time when the "last fault" occurred			1 hour	Q	Q
		Elapsed Time 1						
	U3-06	Accumulated time of second fault	Cumulative operation time when the "2nd to last fault" occurred			1 hour	Q	Q
		Elapsed Time 2						
	U3-07	Accumulated time of second fault	Cumulative operation time when the "3rd to last fault" occurred			1 hour	Q	Q
		Elapsed Time 3						
	U3-08	Accumulated time of second fault	Cumulative operation time when the "oldest fault" occurred			1 hour	Q	Q
		Elapsed Time 4						

\* The faults of CPF00, 01, 02, 03, UV1 and UV2 are not recorded in the fault history

### (c) Monitoring at Startup

In operation mode, the frequency reference, output frequency, output current, and output voltage can be monitored immediately if the default settings are being used. One of these four values, the output voltage, can be changed to a different value. When a value other than the output voltage is to be monitored, set that value's number in constant o1-01 (user monitor selection).

When the power is turned ON, the frequency reference appears in the data display if the default settings are being used. Any one of the four values monitored at startup (frequency reference, output frequency, output current, or the value set in constant o1-01) can be selected to appear when the power is turned ON. The value that appears at startup is determined by constant o1-02 (Power-ON Monitor).

Constants o1-01 and o1-02 can be changed in the BASIC or ADVANCED access levels. These constants can be changed during operation.

## (d) Monitor Display

This manual explains each individual constant as shown in the following table.

Constant No.	Name	Change during Operation	Setting Range	Unit	Initial Setting	Open Loop Vector	Flux Vector
o1-01	Monitor selection	○	4 to 28	—	6	B	B

Select the monitor item numbers to be displayed (values of \*\* in UI-\*\*) Selected monitor items are displayed in place of output voltage values.

Change during Run	Indicates whether the constant is changeable during run or not	
	○	Can be changed during run
	×	Cannot be changed during run
Setting Range	Constant setting range	
Unit	Setting unit	
Initial Setting	Value set prior to shipment (Each control method has the initial setting The set values of some constants are changed when the control method is changed)	
Open Loop Vector, Flux Vector	Indicates that the constant can be read/set in the control method and the access level	
	Q	These items can be monitored at all access levels (QUICK-START, BASIC, and ADVANCED)
	B	These items can be monitored at BASIC and ADVANCED access levels
	A	These items can be monitored at ADVANCED access level only
	×	These items cannot be monitored in the control method shown









Constant No.	Name	Change during Operation	Setting Range	Unit	Initial Setting	Open Loop Vector	Flux Vector
o1-02	Monitor selection after power up	○	1 to 4	—	1	B	B

- Select the item for display when power supply is turned ON.

Set Value	Contents
1	Frequency reference is displayed when power supply is turned ON
2	Output frequency is displayed when power supply is turned ON
3	Output current is displayed when power supply is turned ON
4	Item set to o1-01 is displayed when power supply is turned ON

**[Example] Changing Output Voltage to Output Current (Operation in BASIC)**

If the access level is not in BASIC, change the level to BASIC. Refer to "Changing the Access Level from QUICK-START to BASIC".

Step	Key Sequence	Digital Operator Display	Remarks
①		** Main Menu ** Operation	
②	 Depress twice	** Main Menu ** Programming	
③		Function b1 Sequence	Changed to constant reading (function) level
④	 Depress twice	Function o1 Monitor Select	
⑤		User Monitor Sel Output Voltage	Changed to constant setting level
⑥		o1-01 = 6*** Output Voltage	
⑦	 Depress twice	o1-01 = 8 Output kWatts	
⑧		Entry Accepted	Writes in the new setting
		User Monitor Sel Output kWatts	After a few seconds, the operator display is as shown on the left







Output power has been set in place of output voltage.



**【Example】 Changing Monitor Display Item at Power-ON to Output Current (Operation in BASIC)**

Continued from the previous operation step, the following shows the procedures to change o1-02 (monitor selection after power up).

The access level is already set in BASIC and does not have to be reset.

Step	Key Sequence	Digital Operator Display	Remarks
①	—	User Monitor Sel Output kWatts	Check the display
②		Power-On Monitor - Frequency Ref	
③		o1-02 = 1* * * Frequency Ref	
④	 Depress twice	o1-02 = 3 Output Current .	
⑤		Entry Accepted	Writes-in the new setting
		Power-On Monitor Output Current	After a few seconds, the operator display is as shown on the left
⑥		Function o1 Monitor Select	
⑦		* * Main Menu * * Programming	

Output current has been set in monitor selection after power ON.

## (5) Initialize Mode

The initialize mode is used to select the language displayed in the digital operator, the access level, the control method and the constant initialization. The following shows the initialize mode constant level.

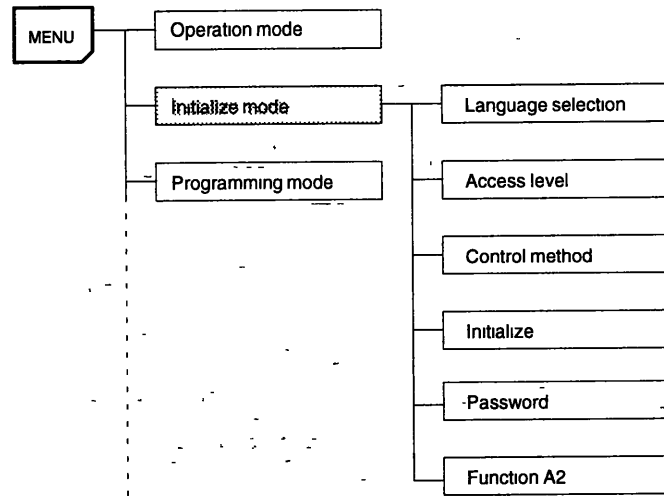

Initialize Mode Constant Level







## (a) Language Selection for Digital Operator Display

Use constant A1-00 to select the language for operator display. This constant is not initialized by constant initialization. To return to the initial setting, reset the constant A1-00.

Constant No	Name	Change during Operation	Setting Range	Unit	Initial Setting	Open Loop Vector	Flux Vector
A1-00	Language selection	○	0 English 1 Japanese	-	0	Q	Q

## 【Example】 Changing Display Language

The following procedures show how to change the display from English to Japanese.

Step	Key Sequence	Digital Operator Display	Remarks
①		** Main Menu ** Operation	Changed to constant setting level
②		** Main Menu ** Initialize	
③		Select Language English	
④		A1-00 = 0*** English	
⑤		A1-00 = 1 ニホンゴ	
⑥		ジョウスウ カキコミカン	
		ゲンゴ センタク ニホンゴ	After a few seconds, the operator display is as shown on the left

The display language has been set in Japanese.

(b) Setting the Access Level

Use constant A1-01 to set the constant access level (reading/setting range of constant). Some constants cannot be read/set depending on the control method.

Constant No	Name	Change during Operation	Setting Range	Unit	Initial Setting	Open Loop Vector	Flux Vector
A1-01	Access level	○	0 to 4	—	4 (A)	A	A

Access Level Settings

Set Value	Contents	
0	Exclusive for monitoring	This setting allows operation mode and initialize mode to be displayed or changed. Use this setting to prevent constant settings from being changed.
1	Constants for user selection	This setting allows only the user-selected constants (up to 32) to be displayed or changed. Select the desired constants as "User Constants" in constants A2-01 through A2-32.
2	QUICK-START	This setting allows the constants required to start the inverter (approx. 25) to be displayed or changed.
3	BASIC	This setting allows the commonly used constants to be displayed or changed.
4	ADVANCED	This setting allows all constants to be displayed or changed.

(c) Setting the Control Method

Use constant A1-02 to select one of the four control methods. This constant is not initialized by constant initialization. To return to the initial setting, reset constant A1-02.











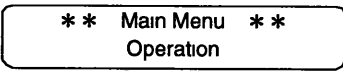

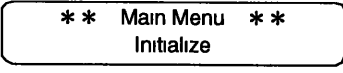
Constant No.	Name	Change during Operation	Setting Range	Unit	Initial Setting	Open Loop Vector	Flux Vector
A1-02	Control Method	×	0 to 3	—	2 (open loop vector)	Q	Q

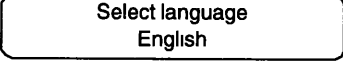
Control Method Settings

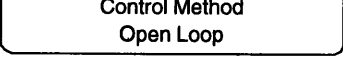
Set Value	Contents
2	Open loop vector (Vector control using the inverter's internal speed information)
3	Flux vector (Vector control using a PG speed controller card)

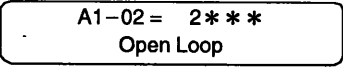
**[Example] Changing Control Method to Flux Vector**

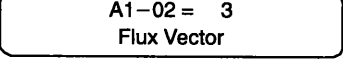
The following procedures show how to change the control method to flux vector.

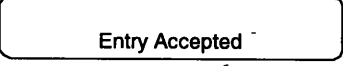
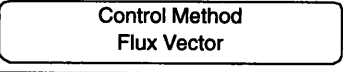
Step	Key Sequence	Digital Operator Display	Remarks	
①				
②				
③				
④	 Depress twice			
⑤				Changed to constant setting level
⑥				
⑦		 		Writes-in the new setting  After a few seconds, the operator display is as shown on the left

The control method has been changed to flux vector.

**Table 10 Control Method Characteristics**

Characteristic	Open Loop Vector	Flux Vector
Basic control method	Current vector control without PG	Current vector control with PG
Speed detector	Not required	Required (pulse generator)
Optional speed detectors	Not required	PG-B2 or PG-X2
Speed control range	1:100	1:1000
Starting torque	150%/1Hz	150%/0Hz
Speed control accuracy	±0.2%	±0.02%
Torque limit	Possible	Possible
Torque control	Not possible	Possible

(d) Initializing the Constants

Initializing means returning the set values to the values set at the factory prior to shipment. If the factory settings have been changed, record the new values.

Constant No	Name	Change during Operation	Setting Range	Unit	Initial Setting	Open Loop Vector	Flux Vector
A1-03	Initialize	×	0, 1110, 2220	—	0	Q	Q

Initialize Constats Settings

Set Value	Contents
0	Returns to the initialize display without initializing any constants
1110	Initializes the constants to the user settings
2220	2-wire sequential initialization (Initializes the constants to the factory settings )

- Initializing Constats to the User Settings





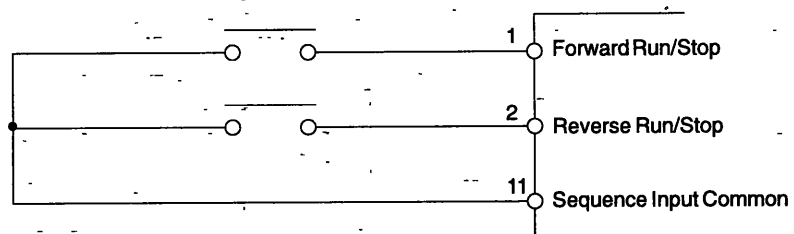





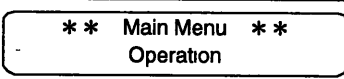

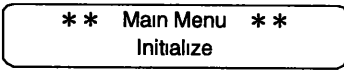
This function initializes the constants to values that have been recorded as user settings. To record the user settings, change the constants to the desired values and then set constant o2-03 (user defaults) to 1. (The 1110 function is disabled when constant o2-03 is 0.)

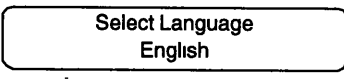
- Example of Wiring for 2-wire Sequential Operation

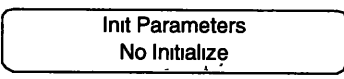

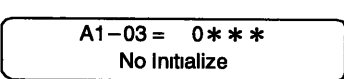
**[Example] Initializing Constants with 2-wire Sequence**

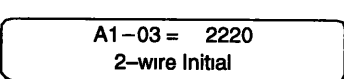
The following procedures show how to initialize constants with 2-wire sequence

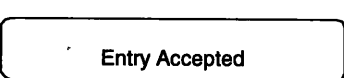
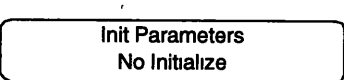
Step	Key Sequence	Digital Operator Display	Remarks
①			
②			
③			
④	 Depress 3 times		
⑤			
⑥			
⑦		  	Writes-in the new setting  After a few seconds, the operator display is as shown on the left

The initialization has been completed with 2-wire sequence.

**(e) Passwords**

Use constants S1-09 and A1-05 to write-protect the programming-mode constants. The constants cannot be set/read if the contents of S1-09 and A1-05 do not match.

Constant A1-05 can be displayed by displaying S1-09 and depressing [MENU] key while simultaneously depressing [RESET] key. (A1-05 cannot be displayed with the usual key sequences.)

It is possible to set/read the programming-mode constants again when the same password is written to A1-05 and S1-09.

Constant No.	Name	Change during Operation	Setting Range	Unit	Initial Setting	Open Loop Vector	Flux Vector
S1-09	Password setting	×	0 to 9999	—	0	A	A

Constant No.	Name	Change during Operation	Setting Range	Unit	Initial Setting	Open Loop Vector	Flux Vector
A1-05	Password	×	0 to 9999	—	0	Q	Q

(f) User Constants















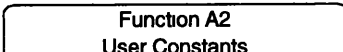

Constants A2-01 through A2-32 specify the constants that can be read/set when the access level constant (A1-01) is set to 1. Constants A2-01 through A2-32 can be changed only in ADVANCED and cannot be changed during operation.

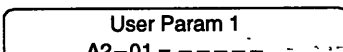
Operation	The QUICK-START level constants can be displayed
Initialize	The QUICK-START level constants can be read or set
Programming	Only the constants specified in A2-01 through A2-32 can be read or set
Auto-tuning	The constants cannot be displayed
Modified constants	The constants cannot be displayed

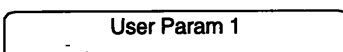

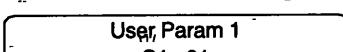

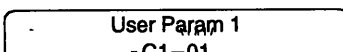

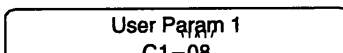
**[Example] Setting User Constants**

The following procedures show how to specify constant C1-08 (deceleration time 4) in user constant A2-01 and set the access level to the user program.

If the access level is in BASIC, change the level to ADVANCED. Refer to "Changing the Access Level from QUICK-START to BASIC".

Step	Key Sequence	Digital Operator Display	Remarks
①			
②			
③			
④			
⑤			
⑥			The first digit blinks
⑦	 Depress twice		
⑧	 Depress twice		Writes-in set value 0000
⑨	 Depress 7 times		



Step	Key Sequence	Digital Operator Display	Remarks
⑩		Entry Accepted	Writes-in the new setting
		User Param 1 A2-01 = C1-08	After a few seconds, the operator display is as shown on the left
⑪		Function A2 User Constants	
⑫	 Depress twice	Access Level ADVANCED	
⑬		A1-01 = 4*** ADVANCED	
⑭	 Depress twice	A1-01 = 1 User Program	User constants in access level can be set only after one or more constants are set in user setting constants (A2-01 to A2-32) If these constants are not set, user constants are not displayed in access level (A1-01)
⑮		Entry Accepted	Writes-in the new setting
		A1-01 = 4*** ADVANCED	If [DATA/ENTER] key is not depressed for over one minute, the operator display returns as shown on the left In this case, repeat from step 14
		Access Level User Program	After a few seconds, the operator display is as shown on the left
⑯		** Main Menu ** Initialize	

The access level has been set to user constants.

## User Constants Setting Levels (Reference)

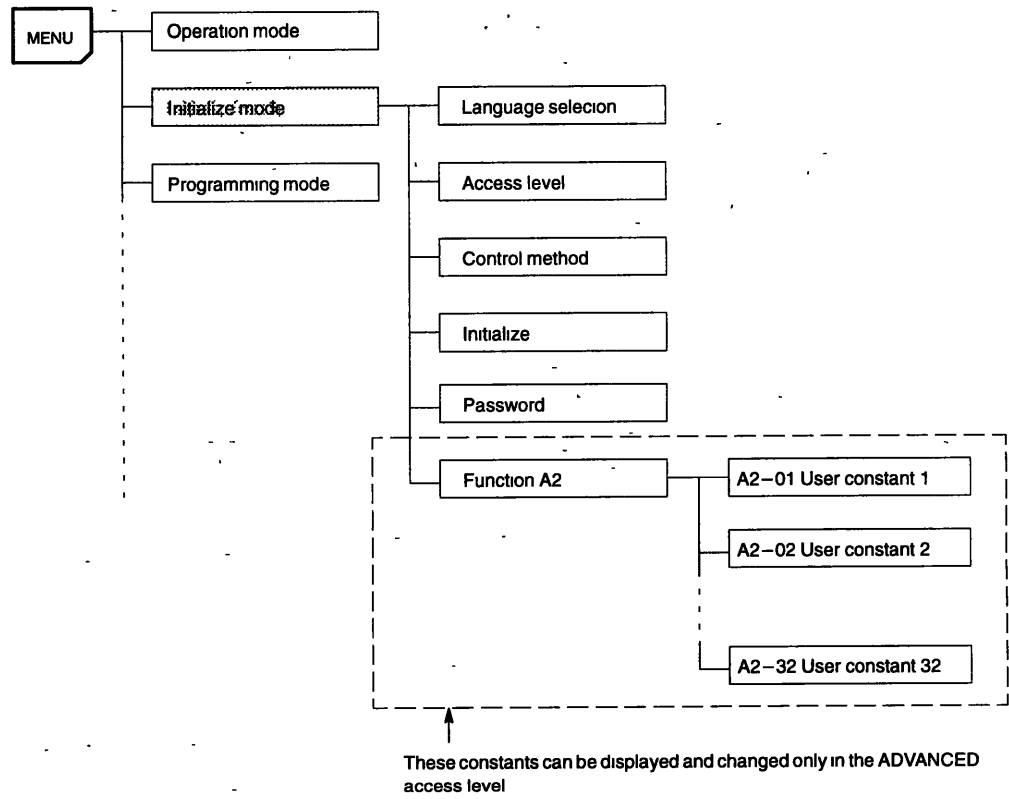

## (6) Programming Mode

The inverter constants can be set in programming mode. The constants which can be read and set depend on the access levels and control methods that are being used.

The following table shows the constant groups and the functions

Table 11 Constant Group in Programming Mode

Group	Function	Contents	Control Method		
			Open Loop Vector	Flux Vector	
b	Application	b1 Sequence	Settings such as the reference input method	○	○
		b2 DC Braking	DC braking function settings	○	○
		b3 Speed Search	Speed search function settings	○	○
		b4 Delay Timers	Timer function settings	○	○
		b5 PID Control	PID control settings	○	○
		b6 Reference Hold	Acceleration/deceleration time dwell function settings	○	○
		b7 Droop Control	Droop control (speed droop) settings	×	○
		b9 Zero Servo	Stop in the position loop	×	○
C	Tuning	C1 Accel/Decel	Acceleration/deceleration time settings	○	○
		C2 S-Curve Acc/Dec	S-curve characteristics for acceleration/deceleration times	○	○
		C3 Motor-Slip Compensation	Slip compensation function settings	○	○
		C4 Torque Compensation	Torque compensation function settings	○	×
		C5 ASR Tuning	Speed control loop constant settings	×	○
		C6 Carrier Frequency	Carrier frequency settings	○	○
		C8 Factory Tuning	Adjustment for open loop vector control	○	×
d	Reference	d1 Preset Reference	Operator frequency reference settings	○	○
		d2 Reference Limit	Frequency upper and lower limit settings	○	○
		d3 Jump Frequencies	Prohibited frequency settings	○	○
		d4 Sequence	Hold for analog frequency reference	○	○
		d5 Torque Control	Constant settings for torque control	×	○
E	Motor	E1 V/f Pattern	Sets the motor V/f characteristics	○	○
		E2 Motor Setup	Sets the motor constants	○	○
F	Options	F1 PG Option Setup	Constant settings for a PG card	×	○
		F2 AI-14 Setup	Constant settings for an analog reference card	○	○
		F3 DI-08, 16 Setup	Constant settings for a digital reference card	○	○
		F4 AO-08, 12 Setup	Constant settings for an analog monitor card	○	○
		F5 DO-02 Setup	Constant settings for a digital output card	○	○
		F7 PO-36F Setup	Constant settings for a pulse monitor card	○	○

Group	Function	Contents	Control Method		
			Open Loop Vector	Flux Vector	
H	Terminal	H1 Digital Inputs	Function selection for multi-function inputs	<input type="radio"/>	<input type="radio"/>
		H2 Digital Outputs	Function selection for multi-function outputs	<input type="radio"/>	<input type="radio"/>
		H3 Analog Inputs	Function selection for analog inputs	<input type="radio"/>	<input type="radio"/>
		H4 Analog Outputs	Function selection for analog outputs	<input type="radio"/>	<input type="radio"/>
		H5 Serial Communication Setup	Selects serial communication (MEMOBUS)	<input type="radio"/>	<input type="radio"/>
L	Protection	L1 Motor Overload	Overload protection settings and selection	<input type="radio"/>	<input type="radio"/>
		L2 Power Loss Rideshru	Selects the power-loss processing method	<input type="radio"/>	<input type="radio"/>
		L3 Stall Prevention	Stall prevention settings and selection	<input type="radio"/>	<input type="radio"/>
		L4 Reference Detection	Frequency detection settings and selection	<input type="radio"/>	<input type="radio"/>
		L5 Fault Restart	Fault restart function settings	<input type="radio"/>	<input type="radio"/>
		L6 Torque Detection	Overtorque detection settings and selection	<input type="radio"/>	<input type="radio"/>
		L7 Torque Limit	Torque limit settings	<input type="radio"/>	<input type="radio"/>
		L8 Hardware Protection	Overheating and phase loss protection settings	<input type="radio"/>	<input type="radio"/>
o	Operator	o1 Monitor Selection	Selects the display and setting methods	<input type="radio"/>	<input type="radio"/>
		o2 Key Selection	Key function selection and other constants	<input type="radio"/>	<input type="radio"/>
S	Elevator	S1 Elevator Function	Selects the elevator functions	<input type="radio"/>	<input type="radio"/>

Display Level of Each Access Level

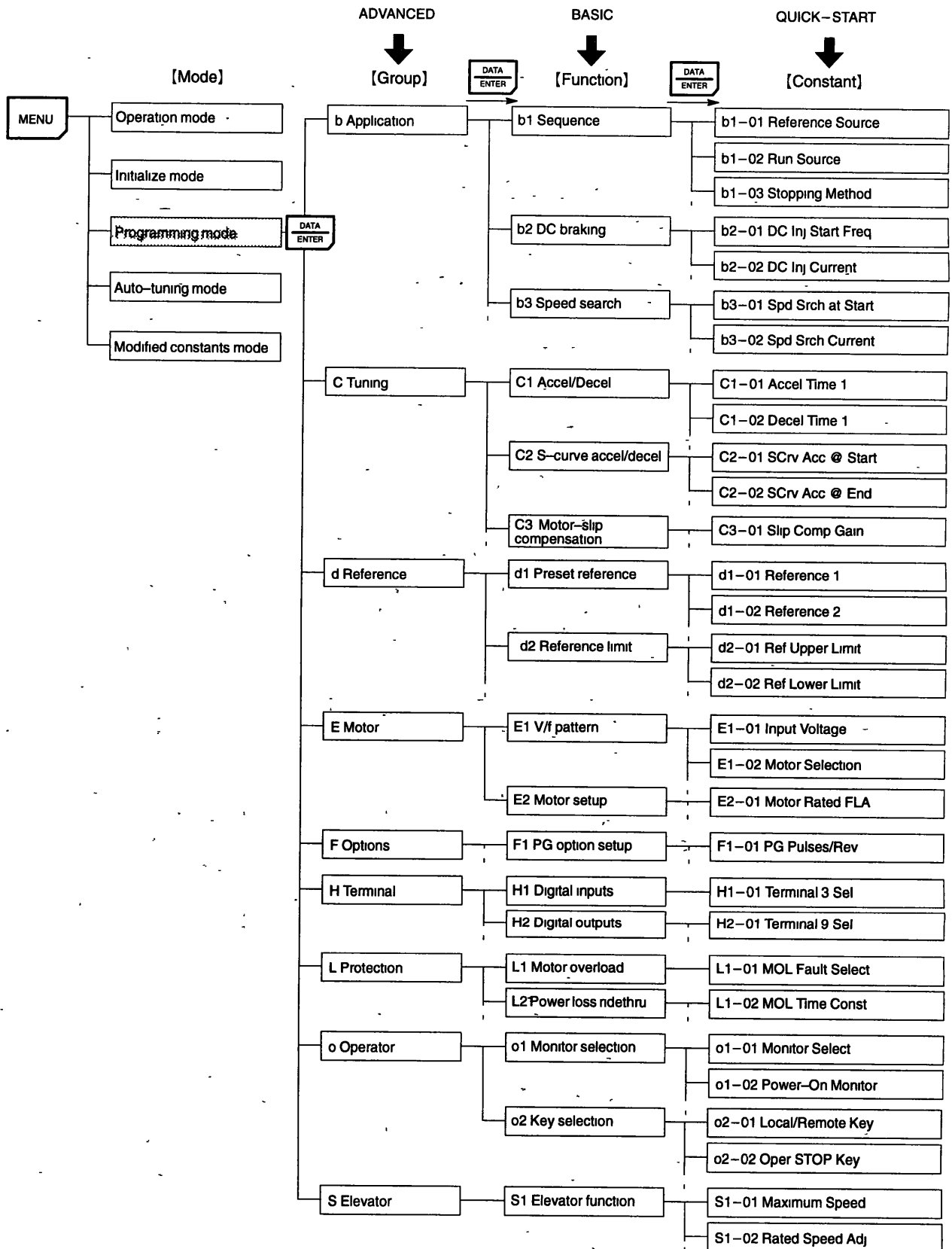

## (7) Auto-tuning Mode











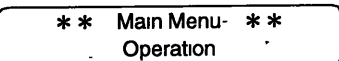

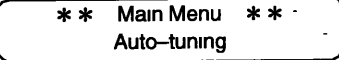

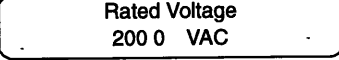

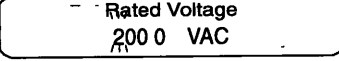

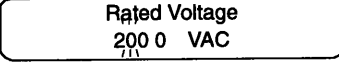
Do not connect a load to the motor when performing auto-tuning. It may cause incorrect motor constant settings.

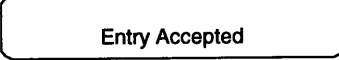
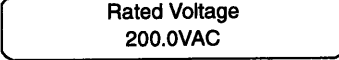

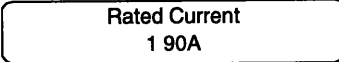

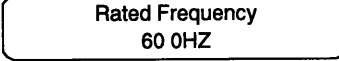

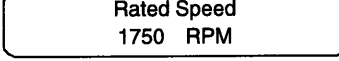



The auto-tuning function automatically sets the motor constants required for operation. This function differs from servo system auto-tuning (to check the size of a load).

Set rated voltage, rated current, rated frequency, and number of poles indicated on the motor nameplate, and depress [RUN] key. Then motor constants (E1-01 to E2-08) will be written-in by calculating the nameplate values and auto-tuning.

### [Example] Setting Auto-tuning Mode

Auto-tuning is set at all access levels.

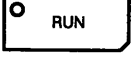
Step	Key Sequence	Digital Operator Display	Remarks
①			
②	 Depress 3 times		
③			
④			The leading digit blinks When [^] key is depressed, blinking value increases When [v] key is depressed, blinking value decreases
⑤			The digit to be set moves to the right and blinks Follow the above procedures as outlined in step 4
⑥			After selecting values for steps 4 and 5, depress [DATA/ENTER] key The operator display is as shown on the left The value is written-in
			After a few seconds, the operator display is as shown on the left
⑦			
⑧			Depress the keys as in steps 4, 5, 6 of rated voltage setting
⑨			
⑩			Depress the keys as in steps 4, 5, 6 of rated voltage setting
⑪			
⑫			Depress the keys as in steps 4, 5, 6 of rated voltage setting

Step	Key Sequence	Digital Operator Display	Remarks
⑬		Number of Poles 4	Depress the keys as in steps 4, 5, 6 of rated voltage setting
⑭	  		
⑮		Select Motor 1/2 1	Depress the keys as in steps 4, 5, 6 of rated voltage setting Setting other than "1" cannot be made
⑯	  		
⑰		Tuning Ready? Press RUN Key	Starts auto-tuning The motor rotates for approx one minute Then the motor stops automatically
⑱		Tune Processing □Hz□□□□A	
		Tune Successful	
⑲		** Main Menu ** Operation	

Returns to the operation mode display.

## (8) Modified Constants Mode











The modified constants mode is used to read/set the constants that have been changed from factory settings. If the constants have not been changed, they are not displayed in the modified constants mode.

When any constant set value has been changed in the programming mode (b1-01 through o2-08), the constant will be displayed after depressing [DATA/ENTER] key in the modified constants mode. The constants in the initialize mode are not displayed.

### 【Example】 Changing Frequency Reference in the Modified Constants Mode

The set values of constants C1-01 (acceleration time 1) and d1-01 (preset reference 1) have been changed from the preset factory settings. "20.0 Sec" is set in C1-01 and "60.00 Hz" is in d1-01.

The procedures below show how to change d1-01 set value to "30.00 Hz" in the modified constants mode.

Step	key Sequence	Digital Operator Display	Remarks
①		** Main Menu ** Operation	
②		** Main Menu ** Modified Consts	
③		Accel Time-1 C1-01 = 20.0Sec	
④		Frequency Ref 1 d1-01 = 60.00 HZ	
⑤		Frequency Ref 1 060.00 HZ	
⑥		Frequency Ref 1 060.00 HZ	Blinking digit moves 1 place down
⑦		Frequency Ref 1 030.00Hz	
⑧	Depress 3 times 	Entry Accepted	30.00 Hz is written-in
		Frequency Ref 1 d1-01 = 30.00Hz	After a few seconds, the operator display is as shown on the left
⑨		** Main Menu ** Modified Consts	Preset reference 1 is changed to 30.00 Hz in the modified constants mode
⑩		** Main Menu ** Operation	

Returns to the operation mode display.



## 5 OPERATION



### WARNING

- Only turn ON the input power supply after replacing the front cover. Do not remove the cover while current is flowing.  
Failure to observe this warning can result in an electrical shock.
- When the retry function (L5-02) is selected, do not approach the inverter or the load, since it may restart suddenly after being stopped.  
(Construct machine system, so as to assure safety for personnel, even if the inverter should restart.) Failure to observe this warning can result in personal injury.
- Since the stop button can be disabled by a function setting, install a separate emergency stop switch.  
Failure to observe this warning can result in personal injury.
- If an alarm is reset with the operation signal ON, the inverter restarts automatically. Only reset the alarm after verifying that the operation signal is OFF.  
Failure to observe this warning can result in personal injury.



### CAUTION

- Never touch the heatsink or discharging resistor since the temperature is very high.  
Failure to observe this caution can result in harmful burns to the body.
- Since it is easy to change operation speed from low to high speed, verify the safe working range of the motor and machine before operation.  
Failure to observe this caution can result in personal injury and machine damage.
- Install a holding brake separately if necessary.  
Failure to observe this caution can result in personal injury.
- Do not change signals during operation.  
The machine or the inverter may be damaged.
- All the constants of the inverter have been preset at the factory. Do not change the settings unnecessarily.  
The inverter may be damaged. For supply voltage, follow Par. 5.3.

This chapter describes operation selection, test run checkpoints, line voltage settings, and test runs of the VS-676GL5.

#### NOTE

When power supply is turned ON, Frequency Ref  
U1-01 = 00 00 HZ is displayed on the digital operator. In this status, frequency reference and run commands are input to rotate the motor.

## 5.1 OPERATION MODE SELECTION

The VS-676GL5 has two operation modes, LOCAL and REMOTE, as described below. These two modes can be selected by the digital operator "LOCAL/REMOTE" key only while the operation is stopped. The selected operation mode can be verified by observing the digital operator SEQ and REF LEDs as shown below. The operation mode is set to REMOTE (run by control circuit terminals 13 and 14 frequency reference and run command from a control circuit terminal) prior to shipment. Multi-function contact inputs from control circuit terminals 3 to 8 are enabled in both operation modes LOCAL/REMOTE.

- **LOCAL** Both frequency reference and run command are set by the digital operator. SEQ and REF LEDs go OFF.
- **REMOTE** Master frequency reference and run command can be selected as described below.

Table 12 Reference Selection in REMOTE Mode

Constant No	Digital Operator Display	Name	Remarks
b1-01	Reference Source	Reference selection	0 Master frequency reference from operator (d1-01) (Operator REF LED is OFF) 1 Master frequency reference from control circuit terminals 13 and 14 (Operator REF LED is ON) 2 Master frequency reference set by transmission (Operator REF LED blinks) 3 Master frequency reference set by option (Operator REF LED blinks)
b1-02	Run Source	Operation method selection	0 Master frequency reference from operator (d1-01) (Operator REF LED is OFF) 1 Master frequency reference from control circuit terminals 13 and 14 (Operator REF LED is ON) 2 Master frequency reference set by transmission (Operator REF LED blinks) 3 Master frequency reference set by option (Operator REF LED blinks)

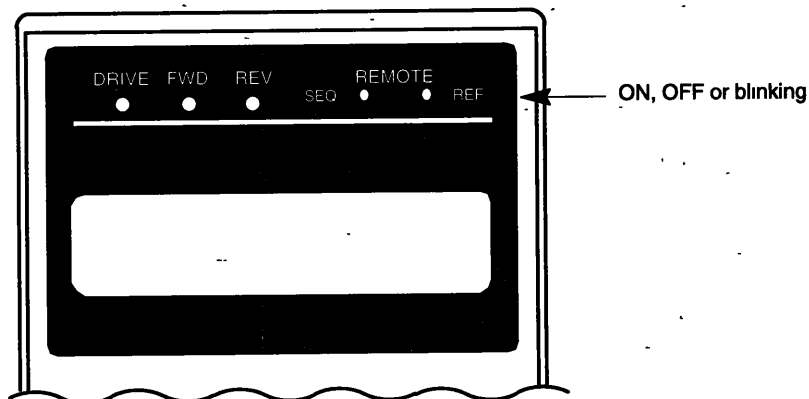

## 5.2 TEST RUN CHECKPOINTS

To assure safety, prior to initial operation, disconnect the machine coupling so that the motor is isolated from the machine. If initial operation must be performed while the motor is still coupled to the machine, use great care to avoid potentially hazardous conditions. Check the following items before a test run.

- Wiring and terminal connections are correct.
- No short circuit caused by wire clippings.
- Screw-type terminals are securely tightened.
- Motor is securely mounted.
- All items are correctly earthed (grounded).

## 5.3 SETTING THE LINE VOLTAGE USING JUMPER (FOR 400V CLASS 13kW AND ABOVE)

Set the line voltage jumper according to the main circuit power supply. (See Fig. 17.) Insert the jumper at the appropriate location corresponding to the input line voltage. It has been preset at the factory to 440V.

Set the line voltage jumper as follows:

- ① Turn OFF the power supply and wait for at least one minute (3 minutes for models of 30kW or above).
- ② Remove the front cover.
- ③ Insert the connector corresponding to the line voltage.

Example

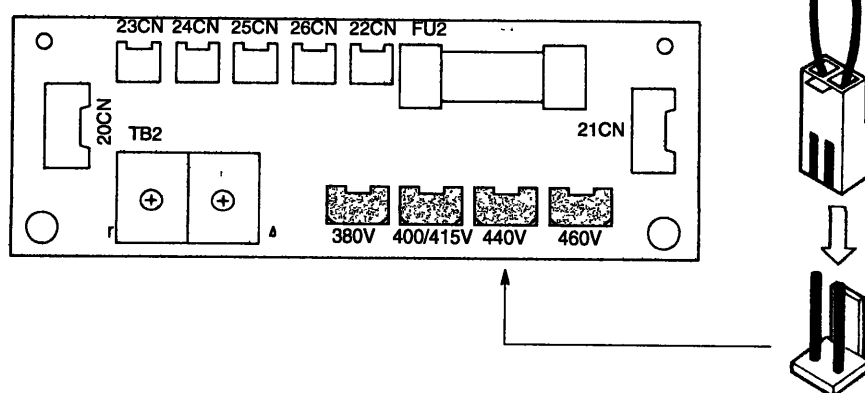

Fig. 15 Line Voltage Jumper (For 400V Class 13kW to 30kW)

## 5.4 TEST RUN

This section describes simple operation examples for rotating a motor, one is the operation by the digital operator and the other is by the control circuit terminal signals.

### (1) Digital Operator Display at Power ON

When the system is ready for operation, turn ON the power supply. Verify that the inverter powers up properly. If any problems are found, turn OFF the power supply immediately. The digital operator display illuminates as shown below when turning the power supply ON

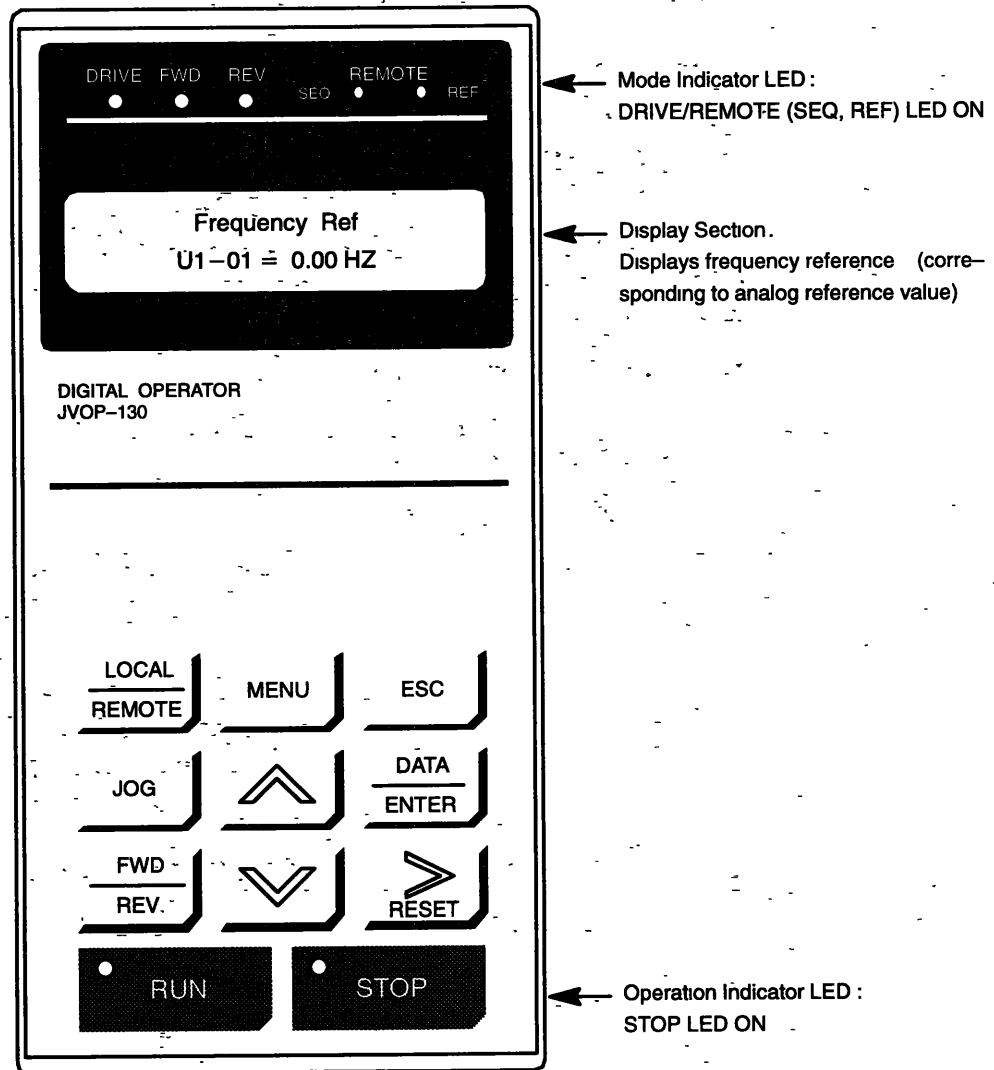

Fig. 16 Digital Operator Display at Power ON

## (2) Operation Check Points

Check the following items during operation

- Motor rotates smoothly.
- Motor rotates in the correct direction.
- Motor does not have abnormal vibration or noise.
- Acceleration and deceleration are smooth.
- Current matches the load flow.
- Status indicator LEDs and digital operator display are correct

## (3) Example of Basic Operation

## (a) Operation by Digital Operator

The operation by the digital operator is performed in LOCAL mode. Refer to chapter 4 before operation.

The diagram below shows a typical operation pattern using the digital operator.

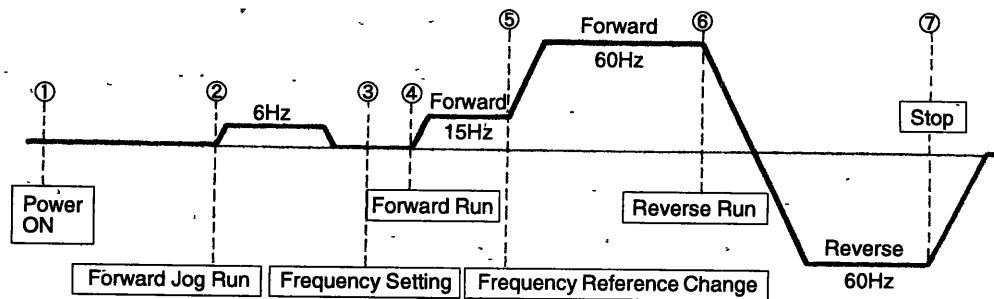









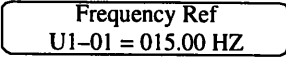
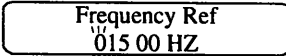
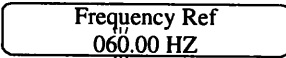
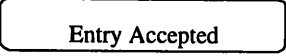
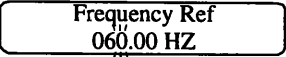
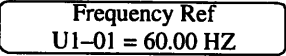
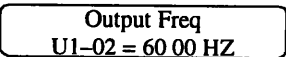

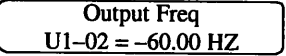

Fig. 17 Operation Sequence by Digital Operator

Table 13 Typical Operation by Digital Operator

Description	Key Sequence	Digital Operator Display
<p>① Power ON</p> <ul style="list-style-type: none"> <li>· Displays frequency reference value.</li> </ul>		<p>Frequency Ref U1-01 = 0 00 HZ</p>
<p>Operation Condition Setting</p> <ul style="list-style-type: none"> <li>· Select LOCAL mode</li> </ul>	<p>LOCAL REMOTE</p>	<p>REMOTE LED OFF (SEQ, REF)</p>
<p>② Forward Jog Run (6 Hz)</p> <ul style="list-style-type: none"> <li>· JOG run procedure (Runs while depressing JOG key.)</li> </ul>	<p>JOG</p>	
<p>③ Frequency Setting</p> <ul style="list-style-type: none"> <li>· Change reference value</li> </ul>	<p>DATA ENTER</p>	<p>Frequency Ref 000.00 HZ</p>
	<p>Digit to be changed blinks</p>	<p>Frequency Ref 015.00 HZ</p>
	<p>Change the value by depressing</p> <p>↓ ↑ RESET</p>	<p>Frequency Ref 015.00 HZ</p>
	<p>DATA ENTER</p>	<p>Entry Accepted</p>
<ul style="list-style-type: none"> <li>· Write-in set value</li> </ul>		<p>Frequency Ref 015.00 HZ</p>
<ul style="list-style-type: none"> <li>· Select output frequency monitor display.</li> </ul>	<p>ESC</p> <p>↗</p>	<p>Frequency Ref U1-01 = 15 00 HZ</p> <p>Output Freq U1-02 = 0.00 HZ</p>
<p>④ Forward Run</p> <ul style="list-style-type: none"> <li>· Forward run (15 Hz)</li> </ul>	<p>○ RUN</p>	<p>Output Freq U1-02 = 15 00 HZ</p>
		<p>RUN LED lights FWD LED lights.</p> <p>● RUN</p>

(Cont'd)

Table 13 Typical Operation by Digital Operator (Cont'd)

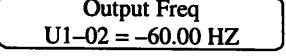
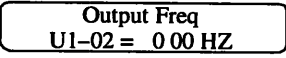
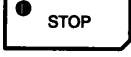
Description	Key Sequence	Digital Operator Display
<p>⑤ Frequency Reference Value Change (15 Hz to 60 Hz) · Select frequency reference value display</p> <p>· Change set value</p> <p>· Write-in set value.</p> <p>· Select output frequency monitor display</p>	<p></p> <p></p> <p>Change the value by depressing</p> <p>  </p> <p></p> <p></p> <p></p>	<p></p> <p></p> <p></p> <p></p> <p></p> <p></p> <p></p>
<p>⑥ Reverse Run · Switch to reverse run.</p>	<p></p>	<p></p> <p>REV LED lights.</p>
<p>⑦ Stop · Decelerates to a stop.</p>	<p></p>	<p></p> <p>Changed to the display below.</p> <p></p> <p>STOP LED lights (RUN LED blinks during deceleration.)</p> <p></p>

(b) Operation by Control Circuit Terminal Signal

The operation by the control circuit terminal signal is in REMOTE mode

The diagram below shows a typical operation pattern using the control circuit terminal signals.

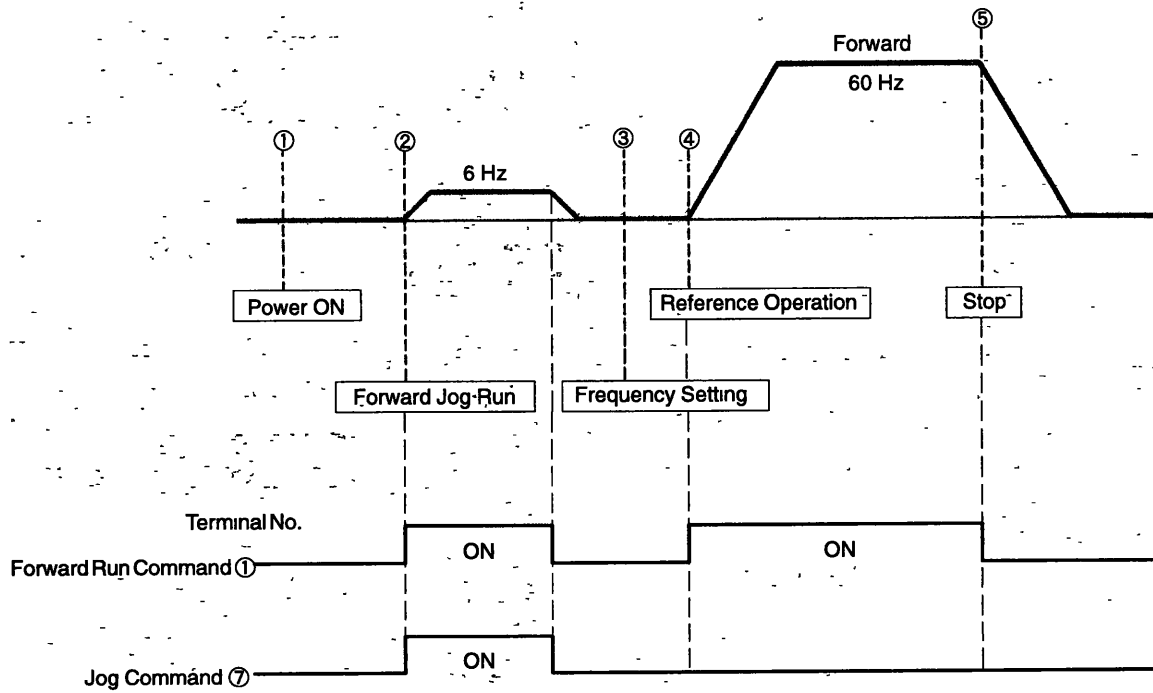





Fig. 18 Operation Sequence by Control Circuit Terminal Signal



Table 14 Typical Operation by Control Circuit Terminal Signal

Description	Key Sequence	Digital Operator Display
<p>① Power ON</p> <ul style="list-style-type: none"> <li>Displays frequency reference value</li> <li>REMOTE mode is preset at the factory.</li> </ul>		<div style="border: 1px solid black; padding: 5px; width: fit-content; margin: 5px auto;">           Frequency Ref            U1-01 = 0.00 HZ         </div> <p>REMOTE LED lights (SEQ, REF)</p>
<p>Output Frequency Display</p> <ul style="list-style-type: none"> <li>Switch to output frequency display</li> </ul>		<div style="border: 1px solid black; padding: 5px; width: fit-content; margin: 5px auto;">           Output Freq            U1-02 = 0.00 HZ         </div>
<p>② Forward Jog Run (6Hz)</p> <ul style="list-style-type: none"> <li>Close between control circuit terminals 1 and 11 with 7 and 11 closed to perform JOG run</li> <li>Open between terminals 1 and 11, 7 and 11 after verifying normal operation.</li> </ul>		<div style="border: 1px solid black; padding: 5px; width: fit-content; margin: 5px auto;">           Output Freq            U1-02 = 6.00 HZ         </div> <p>RUN LED lights FWD LED lights</p> <div style="border: 1px solid black; padding: 5px; width: fit-content; margin: 5px auto;"> <span style="display: inline-block; width: 10px; height: 10px; background-color: black; border-radius: 50%;"></span> RUN         </div>
<p>③ Frequency Setting</p> <ul style="list-style-type: none"> <li>Input frequency reference voltage (current) by control circuit terminal 13 or 14 and verify the input value by the digital operator.</li> </ul>		<div style="border: 1px solid black; padding: 5px; width: fit-content; margin: 5px auto;">           Frequency Ref            U1-01 = 60.00 HZ         </div> <p>For reference voltage 10V</p>
<p>Output Frequency Display</p> <ul style="list-style-type: none"> <li>Select output frequency monitor display.</li> </ul>		<div style="border: 1px solid black; padding: 5px; width: fit-content; margin: 5px auto;">           Output Freq            U1-02 = 0.00 HZ         </div>
<p>④ Forward Run</p> <ul style="list-style-type: none"> <li>Close between control circuit terminals 1 and 11 to perform forward run.</li> </ul>		<div style="border: 1px solid black; padding: 5px; width: fit-content; margin: 5px auto;">           Output Freq            U1-02 = 60.00 HZ         </div> <p>RUN LED lights. FWD LED lights.</p> <div style="border: 1px solid black; padding: 5px; width: fit-content; margin: 5px auto;"> <span style="display: inline-block; width: 10px; height: 10px; background-color: black; border-radius: 50%;"></span> RUN         </div>
<p>⑤ Stop</p> <ul style="list-style-type: none"> <li>Open between control circuit terminals 1 and 11 to stop operation</li> </ul>		<div style="border: 1px solid black; padding: 5px; width: fit-content; margin: 5px auto;">           Output Freq            U1-02 = 0.00 HZ         </div> <p>STOP LED lights (RUN LED blinks during deceleration.)</p> <div style="border: 1px solid black; padding: 5px; width: fit-content; margin: 5px auto;"> <span style="display: inline-block; width: 10px; height: 10px; background-color: black; border-radius: 50%;"></span> STOP         </div>

## 6 MAINTENANCE AND INSPECTION



### WARNING

- Never touch high-voltage terminals in the inverter.  
Failure to observe this warning can result in an electrical shock.
- Replace all protective covers before powering up the inverter. To remove the cover, make sure to shut OFF the molded-case circuit breaker.  
Failure to observe this warning can result in an electrical shock.
- Perform maintenance or inspection only after verifying that the CHARGE LED goes OFF, after the main circuit power supply is turned OFF.  
The capacitors are still charged and can be dangerous.
- Only authorized personnel should be permitted to perform maintenance, inspections or parts replacement.  
[Remove all metal objects (watches, bracelets, etc.) before operation.]  
(Use tools which are insulated against electrical shock.)  
Failure to observe this warning can result in an electrical shock.



### CAUTION

- The control PC board employs CMOS ICs. Do not touch the CMOS elements.  
They are easily damaged by static electricity.
- Do not connect or disconnect wires or connectors while power is applied to the circuit.  
Failure to observe this caution can result in personal injury.

This chapter describes basic maintenance and inspection procedures for the VS-676GL5.

## 6.1 PERIODIC INSPECTION

The VS-676GL5 will function longer if it is kept clean, cool and dry, while observing the precautions listed in Par. 2.3. Check for tightness of electrical connections, discoloration or other signs of overheating or aging. Use Table 26 as your inspection guide. Before servicing, turn OFF AC main circuit power and be sure that the CHARGE LED is OFF.

Table 15 Periodic Inspection

Component	Check	Corrective Action
External Terminals, Unit Mounting Bolts, Connectors, etc.	Loose screws	Tighten
	Loose connectors	Tighten
Heatsink	Build-up of dust and dirt	Blow with dry compressed air of $39.2 \times 10^4$ to $58.8 \times 10^4$ Pa (4 to 6kg/cm <sup>2</sup> ) pressure
Printed Circuit Board	Accumulation of conductive dust or oil	Blow with dry compressed air of $39.2 \times 10^4$ to $58.8 \times 10^4$ Pa (4 to 6kg/cm <sup>2</sup> ) pressure. If dust and oil cannot be removed, replace the board
Cooling Fan	For abnormal noise and vibration Whether the cumulative operation time exceeds 20,000 hours or not	Replace the cooling fan
Power Elements	Accumulation of dust and dirt	Blow with dry compressed air of $39.2 \times 10^4$ to $58.8 \times 10^4$ Pa (4 to 6kg/cm <sup>2</sup> ) pressure
Smoothing Capacitor	Discoloration or odor	Replace the capacitor or inverter unit

## 6.2 PARTS REPLACEMENT SCHEDULE (GUIDELINES)

Replace the following parts periodically, for a long, safe, trouble free working life of VS-676GL5.

Table 16 Parts Replacement Schedule

Parts	Interval (Approx.)	Remarks
Cooling Fan	2 to 3 years	Replace with new one.
Smoothing Capacitor	5 years	Replace with new one. (Decided after inspection)
Breakers or Relays	—	Decided after inspection
Fuse	10 years	Replace with new one.
Aluminum Electrolytic Capacitor on PC Board	5 years	Replace with new one. (Decided after inspection.)

**NOTE**

Operating conditions are as follows:

Ambient temperature : 30°C yearly average

Load factor : 80% or below

Operation rate : 12 hours or below /day

---

## 7 TROUBLESHOOTING

This chapter describes the inverter fault display and the fault contents caused by motor / machine malfunctions and the corrective actions to be taken.

### 7.1 FAULT DIAGNOSIS AND CORRECTIVE ACTIONS

- (1) When the VS-676GL5 detects a fault, the fault is displayed on the digital operator and activates the fault contact output and the motor coasts to a stop. Check the cause in the table below and take the corrective actions.
- (2) If the inspections or corrective actions described cannot solve the problem, contact your YASKAWA representative immediately.
- (3) To restart, turn ON the reset input signal or depress [>RESET] key or shut OFF the main-circuit power supply once, to reset the stop status.

Table 17 Fault Diagnosis and Corrective Actions

Fault Display	Description	Details	Corrective Action	Rank*
UV1 DC Bus Undervolt	Main circuit undervoltage (PUV)	Undervoltage in the direct current main circuit during running Detection level 200 V class Approx 190 V or less 400 V class Approx 380 V or less	<ul style="list-style-type: none"> <li>Check the power supply wiring</li> <li>Correct the line voltage</li> </ul>	A
UV2 CTL PS Undervolt	Control circuit undervoltage (CUV)	Undervoltage in the control circuit during running		A
UV3 MC Answerback	MC fault	The pre-charge contactor opened during running		A
UV Under Voltage	Momentary power loss	<ul style="list-style-type: none"> <li>The main circuit direct current voltage fell below the PUV-level</li> <li>The control power source fell below the CUV level</li> <li>The pre-charge contactor opened</li> </ul>	—	B
OC Overcurrent	Overcurrent (OC)	The inverter output current exceeded the OC level	<ul style="list-style-type: none"> <li>Check the motor coil resistance</li> <li>Extend the accel/decel time</li> <li>Check the motor insulation</li> <li>Multi-meter check</li> </ul>	A
GF Ground Fault	Grounding (GF) (Earth fault)	Inverter output grounding current exceeded 50% of inverter rated current	<ul style="list-style-type: none"> <li>Check that motor insulation has not deteriorated</li> <li>Check that connection between inverter and motor is not damaged</li> </ul>	A
OV DC Bus Overvolt	Overvoltage (OV)	The main circuit direct current voltage exceeded the OV level Detection level 200 V class Approx 400 V 400 V class Approx 800 V	Extend the deceleration time, add braking circuit	A (C during stop)
SC Short Circuit	Load short-circuit (SC)	Inverter output (load) is short-circuited	<ul style="list-style-type: none"> <li>Check the motor coil resistance</li> <li>Check the motor insulation</li> </ul>	A
PUF DC Bus Fuse Open	Fuse blown (FU)	<ul style="list-style-type: none"> <li>The direct current circuit fuse is blown</li> <li>The output transistors were damaged</li> </ul>	Check for damaged transistor, load side short circuit, grounding, etc	A
OH Heatsnk Overtemp	Heatsink overheat (OH)	The transistor heatsink temperature exceeded the allowable value (95°C) The inverter operates according to the setting of constant L8-03	Check the fan and ambient temperature	B
OH1 Heatsnk MAX tmp	Heatsink overheat (OH1)	The transistor heatsink temperature exceeded the allowable value (105°C)	Check the fan and ambient temperature	A
OH2 Over Heat 2	Heatsink overheat alarm (OH2)	Separately-installed thermal overload protector contact is input in the control circuit terminal	Check the thermal overload protector	C
OL1 Motor Overloaded	Motor overload (OL1)	Inverter output exceeded the motor overload level	Reduce the load	A
OL2 Inv Overloaded	Inverter overload (OL2)	Inverter output exceeded the inverter overload level	Reduce the load, extend the acceleration time	A
OL3 Overtorque Det 1	Overtorque detection 1	When torque detection selection 1 is enabled (L6-01=1 to 4), inverter output current (in V/f control) or inverter torque reference (in vector control) exceeded torque detection level 1 (L6-02) for the time set by torque detection time 1 (L6-03) or longer The inverter operates according to the setting of constant L6-01	—	B

Table 28 Fault Diagnosis and Corrective Actions (Cont'd)

Fault Display	Description	Details	Corrective Action	Rank*
OL4 Overtorque Det 2	Overtorque detection 2	When torque detection selection 2 is enabled (L6-01=1 to 4), inverter output current (in V/f control) or inverter torque reference (in vector control) exceeded torque detection level 2 (L6-05) for the time set by torque detection time 2 (L6-06) or longer The inverter operates according to the setting of constant <u>L6-04</u>	—	B
PF Input Pha Loss	Input open-phase	Inverter input power supply has open-phase Large unbalance in input voltage	Check the line voltage Re-tighten the input terminal screws	A
LF Output Pha Loss	Output open-phase	Inverter output has open-phase	Check the output wiring Check the motor impedance Re-tighten the output terminal screws	A
RR Dyn Brk Transistr	Braking transistor failure	The braking transistor has failed	Replace the inverter	A
RH Dyn Brk Resistor	Braking resistor unit overheat	The braking resistor unit temperature has exceeded the allowable value (Protects only inverter built-in type)	Reduce the regenerative load	A
OS Overspeed Det	Overspeed (OS)	The motor speed exceeded the overspeed level (F1-08) Detection time F1-09 The inverter operates according to the setting of constant <u>F1-03</u>	—	B
PGO PG open	PG open circuit (PGO)	The PG line is broken Detection time F1-14 The inverter operates according to the setting of constant <u>F1-02</u>	Check the PG line Check the condition of the motor lock or the load	B
DEV Speed Deviation	Speed deviation (DEV)	The deviation of the speed reference and speed feedback exceeded the regulation level (F1-10) Detection time F1-11 The inverter operates according to the setting of constant <u>F1-04</u>	Check the load	B
OPR Oper Disconnect	Digital operator connection fault	The digital operator was disconnected during operation by run command from the digital operator	Check the operator connection	A
ERR EEPROM R/W Err	EEPROM writing fault (ERR)	EEPROM internal data did not match when initializing the constant	Replace the control card	A
CE Memobus Com Err	Transmission error	Control data was not received normally when power supply is turned ON The inverter operates according to the setting of constant <u>H5-04</u>	Check transmission devices and transmission signals	B
CF Out of Control	Control fault	In open loop vector control, it took 3 seconds or more for torque limit during deceleration to stop	Check the motor-related constants	A
SVE Zero Servo Fault	Zero-servo fault	The rotation position deviated by 10000 r/min or more during zero-servo operation	Check that the torque limit value is not too low Check that the load torque is not excessive Check the noise of PG signals	A
EF External Fault	Operation reference fault (External)	Both FWD and REV run commands were closed for 500 ms or more	Check sequence circuit	C

Table 28 Fault Diagnosis and Corrective Actions (Cont'd)

Fault Display	Description	Details	Corrective Action	Rank*
EF3 External Fault 3	External fault at terminal 3	Fault occurred in the external control circuit The inverter operates according to the settings of constants <u>H1-01 to H1-06</u>	Check the condition of the input terminal If the fault is displayed when terminal is not connected, replace the inverter	B
EF4 External Fault 4	External fault at terminal 4			B
EF5 External Fault 5	External fault at terminal 5			B
EF6 External Fault 6	External fault at terminal 6			B
EF7 External Fault 7	External fault at terminal 7			B
EF8 External Fault 8	External fault at terminal 8			B
OPE01 kVA Selection	kVA selection fault (OPE01)	kVA selection fault	Check and set the constant data	D
OPE02 Limit	Constant setting range fault (OPE02)	Constant data is out of range	Check the constant data settings	D
OPE03 Terminal	Multi-function contact input selection fault (OPE03)	<ul style="list-style-type: none"> <li>· In H1-01 to H1-06 settings</li> <li>· The same values are set except for F, FF and 20 to 2F</li> <li>· Both UP/DOWN and HOLD commands are set</li> <li>· UP and DOWN commands are not set at the same time</li> <li>· Two or more HOLD, UP/DOWN, sample/hold commands are set</li> <li>· Two or more speed search 1, 2, 3 commands are set</li> <li>· In B5-01 setting, both PID control and UP/DOWN commands are set</li> <li>· In H3-09 setting, terminal 13/14 selection and the value other than "Not used" are set at the same time</li> </ul>	Check the constants	D
OPE05 Sequence Select	Option reference selection fault (OPE05)	<ul style="list-style-type: none"> <li>· In B1-01 setting, C-option is not connected although frequency reference from C-option is selected</li> <li>· In B1-02 setting, C-option is not connected although run command from C-option is selected</li> </ul>	Check the constants	D
OPE06 PG Opt Missing	Control method selection fault (OPE06)	<ul style="list-style-type: none"> <li>In A1-02 setting</li> <li>PG is not connected although V/f control with PG feedback is selected</li> <li>PG-B is not connected although flux vector control is selected</li> </ul>	Check the constants	D
OPE07 Analog Selection	Multi-function analog input selection fault (OPE07)	<ul style="list-style-type: none"> <li>· In H3-05 and H3-09 settings, the same values are set except for 0 and 1F</li> <li>· While AI-14B is connected, "0" is set in F2-01 and option/inverter selection is set in multi-function contact input</li> </ul>	Check the constants	D
OPE08 Elevator Table	Multi-function input/output selection fault (OPE08)	<ul style="list-style-type: none"> <li>Any of the following setting faults has occurred</li> <li>· The setting unused in the control method is selected for F4-01 and F4-02</li> <li>· The setting unused in the control method is selected for F5-01 and F5-02</li> <li>· The setting unused in the control method is selected for H1-01 to H1-06</li> <li>· The setting unused in the control method is selected for H2-01 to H2-03</li> <li>· The setting unused in the control method is selected for H3-05 and H3-09</li> <li>· The setting unused in the control method is selected for H4-01 and H4-04</li> <li>· The setting unused in the control method is selected for o1-01</li> </ul>	Check the constants	D

Table 28 Fault Diagnosis and Corrective Actions (Cont'd)

Fault Display	Description	Details	Corrective Action	Rank* (Standard Value)
OPE10 V/f Ptrn Setting	V/f data setting fault (E1-04 to E1-10)	<p>When the settings of E1-04 to E1-10 do not satisfy the following conditions  <math>F_{Max} \geq F_A &gt; F_B \geq F_{Min}</math>                      (E1-04)(E1-06)(E1-07)(E1-09)</p>	Check the constants	D
OPE11 Carr Frq/On-Delay	Constant setting fault	<p>When one of the following setting fault occurs</p> <ul style="list-style-type: none"> <li>Carrier frequency upper limit (C6-01) &gt; 5kHz, and Carrier frequency lower limit (C6-02) ≤ 5kHz</li> <li>Carrier frequency proportional gain (C6-03) &gt; 6 and (C6-01) &lt; (C6-02)</li> <li>Setting error of upper/lower limit of C6-01 to 03 and C8-15</li> </ul>	Check the constants	D
CPF00 COM-ERR(OP&INV)	Control circuit fault 1 (CPF00) (Digital operator transmission fault)	<ul style="list-style-type: none"> <li>Transmission between the inverter and digital operator cannot be established 5 seconds after supplying power</li> <li>MPU peripheral element check fault (initial)</li> </ul>	<ul style="list-style-type: none"> <li>Insert the digital operator connector again</li> <li>Check the control circuit wiring</li> <li>Replace the control card</li> </ul>	A
CPF01 COM-ERR(OP&INV)	Control circuit fault 2 (CPF01) (Digital operator transmission fault)	<ul style="list-style-type: none"> <li>Transmission between the inverter and digital operator is established once after supplying power, but later transmission fault continues for more than 2 seconds</li> <li>MPU peripheral element check fault (online)</li> </ul>	<ul style="list-style-type: none"> <li>Insert the digital operator connector again</li> <li>Check the control circuit wiring</li> <li>Replace the control card</li> </ul>	A
CPF02 BB Circuit Err	Baseblock circuit fault (CPF02)	Inverter control unit fault	Replace the control card	A
CPF03 EEPROM Error	EEPROM fault (CPF03)			A
CPF04 Internal A/D Err	CPU internal A/D converter fault (CPF04)			A
CPF05 External A/D Err	CPU external A/D converter fault (CPF05)			A
CPF06 Option Error	Option connection fault (CPF06)			The option card is not installed correctly
CPF20 Option A/D Error	A/D converter fault in analog speed reference card (CPF20)	Option card (AI-14B) A/D converter fault	Replace the option card	A

\* The ranks are classified as follows

- Rank A Major fault (Motor coasts to a stop, operator indicator lights, and fault contact is output)
- Rank B According to the constants for major/minor fault selection (constants underlined in the table), major fault (Motor coasts to a stop or decelerates to a stop, operator indicator lights, and fault contact is output) or minor fault (Rank C) can be selected
- Rank C Minor fault [Operation continues, operator indicator blinks, no fault contact is output, and minor fault contact is output (when multi-function output is selected)]
- Rank D Warning (Operation cannot be performed, operator indicator lights, no fault contact is output, no minor fault contact is output)



## 7.2 MOTOR FAULTS AND CORRECTIVE ACTIONS

- (1) If any of the following faults occurs in the motor, check the cause and provide the relevant corrective action.
- (2) If these inspections and corrective actions cannot solve the problem, contact your YASKAWA representative immediately.

Table 18 Motor Faults and Corrective Actions

Fault	Check Point	Corrective Action
Motor does not rotate	Power supply voltage applied to power supply terminals L1, L2, L3? CHARGE LED is ON?	<ul style="list-style-type: none"> <li>· Turn ON power supply</li> <li>· Turn OFF power supply, and then ON again</li> <li>· Check power supply voltage</li> <li>· Make sure terminal screws are tight</li> </ul>
	Use rectifier type voltmeter to test Voltage output to output terminals U(T1), V(T2), W(T3) correct?	Turn OFF power supply, then turn ON again
	Motor locks due to excessive load?	Reduce the load and release the lock
	Fault displayed in operator display?	Check troubleshooting table
	FWD or REV run command entered?	Check the wiring
	Frequency setting voltage entered?	<ul style="list-style-type: none"> <li>· Correct the wiring</li> <li>· Check frequency setting voltage</li> </ul>
	Reference selection (b1-01), operation method selection (b1-02) correct?	Input the correct set value
Motor rotation reverses	Wiring of terminals U(T1), V(T2), W(T3) correct?	Match wiring to the phase order of the motor leads U(T1), V(T2), W(T3)
	FWD and REV wiring run signals entered?	Correct the wiring
Motor rotates, but variable speed not available	Wiring of frequency setting circuit correct?	Correct the wiring
	Reference selection (b1-01), operation method selection (b1-02) correct?	With the digital operator, check the reference selection or operation method selection
	Load excessively large?	Reduce the load
Motor r/min too high or too low	Motor ratings (number of poles, voltage) correct?	Check motor nameplate specifications
	Accel/decel speed change ratio for gears, etc correct?	Check speed changer (gears, etc)
	Maximum frequency set value correct?	Check the maximum frequency set value
	Use rectifier voltmeter Voltage between motor terminals not excessively reduced?	Check V/f characteristics values
Motor r/min not stable during operation	Load excessively large?	Reduce the load
	Load variation excessively large?	<ul style="list-style-type: none"> <li>· Reduce the load variation</li> <li>· Increase inverter motor capacity</li> </ul>
	3-phase or single-phase power supply used? For 3-phase power supply, open phase?	<ul style="list-style-type: none"> <li>· For 3-phase power supply, check the wiring if power supply is open phase</li> <li>· For single-phase power supply, connect AC reactor to the power supply</li> </ul>

# APPENDIX 1 SPECIFICATIONS

Table A-1 200V Class Specifications

Models CIMR-L5A <input type="checkbox"/>	24P5	27P5	2011	2015	2022	2030	2037	2045	
Max. Applicable Motor Output * kW	4.5	7.5	11	15	22	30	37	45	
Output Characteristics	Rated Output Current (50% ED for one minute) A	24.8	36.8	48	72	97.5	120	168	225
	Max. Output Voltage	3-Phase, 200/208/220/230 V (Proportional to input voltage)							
	Rated Output Frequency	Up to 400 Hz available by programming							
Power Supply	Rated Input Voltage and Frequency	3-Phase 200/208/220 V 50 Hz 200/208/220/230 V 60 Hz							
	Allowable Voltage Fluctuation	+10%, -15%							
	Allowable Frequency Fluctuation	±5%							
Control Characteristics	Control Method	Sine wave PWM							
	Starting Torque	150% / 1 Hz (150% / 0 r / min with PG) †							
	Speed Control Range	1 / 100 (1 / 1000 with PG) †							
	Speed Control Accuracy	±0.2% (±0.02% with PG) †							
	Speed Response	5 Hz (30 Hz with PG) †							
	Torque Limit	Available (4 quadrants can be changed by parameter setting)							
	Torque Accuracy	±5%							
	Frequency Control Range	0.1 to 400 Hz							
	Frequency Accuracy	Digital command: 0.01% (-10°C to +40°C)							
		Analog command: 0.1% (25°C ±10°C)							
	Frequency Resolution	Digital operator reference: ±0.01 Hz							
		Analog reference: 0.03 Hz/60 Hz (11 bit + code)							
	Output Frequency Resolution	0.001 Hz							
	Overload Capacity	200% of rated output current for 10 seconds							
	Frequency Setting Signal	-10 to 10 V, 0 to 10 V, 4 to 20 mA							
Accel/Decel Time	0.01 to 6000.0 sec (Accel/dec el time setting independently, 4 steps available)								
Braking Torque	Approx 20%								

\* Based on a YASKAWA standard 4-pole motor for max applicable motor output

† Occasional tuning may be required

Table A-1 200V Class Specifications (Cont'd)

Models CIMR-L5A <input type="checkbox"/>	24P5	27P5	2011	2015	2022	2030	2037	2045
Protective Functions	Motor Overload Protection	Protected by electronic thermal overload relay						
	Instantaneous Overcurrent	Motor coasts to a stop at approx 200% of inverter rated current						
	Blown Fuse Protection	Motor coasts to a stop by blown-fuse						
	Overload	Motor coasts to a stop after 10 second at 200% of rated output current						
	Overvoltage	Motor coasts to a stop if converter output voltage exceeds 410 V						
	Undervoltage	Motor coasts to a stop if converter output voltage drops to 190 V or below						
	Momentary Power Loss	Immediately stop by 15 ms and above momentary power loss (Factory setting) Continuous operation during power loss less than 2 sec is equipped as standard						
	Heatsink Overheat	Protected by thermistor						
	Stall Prevention	Stall prevention during accel/decel and constant speed operation						
	Ground Fault	Protected by electronic circuit (Overcurrent level)						
	Power Charge Indication	Charge LED stays ON until bus voltage drops below 50 V						
Environment	Ambient Temperature	-10°C to +40°C (Enclosed wall-mounted type) -10°C to +45°C (Open chassis type)						
	Humidity	90% RH or less						
	Storage Temperature	-20°C to +60°C						
	Location	Indoor (protected from corrosive gases and dust)						
	Elevation	1000 m or less						
	Vibration	9.81m/s <sup>2</sup> (1G) at 10 to less than 20 Hz, up to 1.96m / s <sup>2</sup> (0.2G) at 20 to 50 Hz						

Table A-2 400V Class Specifications

Model CIMR-L5A <input type="checkbox"/>	44P5	47P5	49P5	4013	4015	4022	4030	4037	4045	
Max. Applicable Motor Output * kW	4.5	7.5	9.5	13	15	22	30	37	45	
Output Characteristics	Rated Output Current (50% ED for one minute) A	13.5	20.3	25.5	30.8	36	48.8	72	96	124
	Max. Output Voltage	3-Phase 380/400/415/440/460 V (Proportional to input voltage)								
	Rated Output Frequency	Up to 400 Hz available by programming								
Power Supply	Rated Input Voltage and Frequency	3-Phase 380/400/415/440/460 V 50/60 Hz								
	Allowable Voltage Fluctuation	+10%, -15%								
	Allowable Frequency Fluctuation	±5%								
Control Characteristics	Control Method	Sine wave PWM								
	Starting Torque	150% / 1 Hz (150% / 0 r / min with PG)†								
	Speed Control Range	1:100 (1:1000 with PG)†								
	Speed Control Accuracy	±0.2% (±0.02% with PG)†								
	Speed Response	5 Hz (30 Hz with PG)†								
	Torque Limit	Available (4 quadrants can be changed by parameter setting)								
	Torque Accuracy	±5%								
	Frequency Control Range	0.1 to 400 Hz								
	Frequency Accuracy	Digital command ±0.01% (-10°C to +40°C)								
		Analog command ±0.1% (25°C ± 10°C)								
	Frequency Resolution	Digital operator reference ±0.01 Hz								
		Analog reference ±0.03 Hz/60 Hz (11 bit + code)								
	Output Frequency Resolution	0.001 Hz								
	Overload Capacity	200% of rated output current for 10 seconds								
	Frequency Setting Signal	-10 to 10 V, 0 to 10 V, 4 to 20 mA								
Accel/Decel Time	0.01 to 6000.0 sec (Accel/decel time setting independently, 4 steps available)									
Braking Torque	Approx. 20%									

\* Based on a YASKAWA standard 4-pole motor for max. applicable motor output

† Occasional tuning may be required

Table A-2 400V Class Specifications (Cont'd)

Model CIMR-L5A <input type="checkbox"/>	44P5	47P5	49P5	4013	4015	4022	4030	4037	4045
Protective Functions	Motor Overload Protection	Protected by electronic thermal overload relay							
	Instantaneous Overcurrent	Motor coasts to a stop at approx 200% of inverter rated current							
	Blown Fuse Protection	Motor coasts to a stop by blown-fuse							
	Overload	Motor coasts to a stop after 10 seconds at 200% of rated output current							
	Overvoltage	Motor coasts to a stop if converter output voltage exceeds 820 V							
	Undervoltage	Motor coasts to a stop if converter output voltage drops to 380 V or below							
	Momentary Power Loss	Immediately stop by 15 ms and above momentary power loss (Factory setting) Continuous operation during power loss less than 2 sec is equipped as standard							
	Heatsink Overheat	Protected by thermistor							
	Stall Prevention	Stall prevention during accel/decel and constant speed operation							
	Ground Fault	Protected by electronic circuit (Overcurrent level)							
	Power Charge Indication	Charge LED stays ON until bus voltage drops below 50 V							
Environment	Ambient Temperature	-10°C to +40°C (Enclosed wall-mounted type) -10°C to +45°C (Open chassis type)							
	Humidity	90%RH or less							
	Storage Temperature	-20°C to +60°C							
	Location	Indoor (protected from corrosive gases and dust)							
	Elevation	1000 m or less							
Vibration	9.81 m/s <sup>2</sup> (1G) at 10 to less than 20 Hz, up to 1.96 m/s <sup>2</sup> (0.2G) at 20 to 50 Hz								

## APPENDIX 2 DIMENSIONS (mm)

The figures below show a 200V 4.5kW model. Use open chassis type 200V 11kW, 400V 9.5kW or less with the top and bottom covers removed.

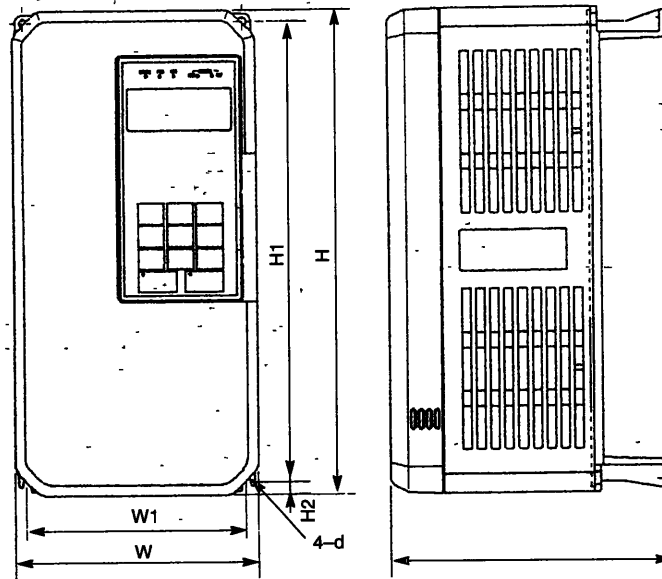

Fig. A-1 Dimensions of VS-676GL5

Table A-3 VS-676GL5 Dimensions (mm) and Approx. Mass (kg)

Voltage	Motor Capacity kW	Open Chassis Type (IP00)							Enclosed Wall-mounted Type (NEMA1)							
		W	H	D	W1	H1	H2	Mass (kg)	W	H	D	W1	H1	H2	Mass (kg)	d*
200V Class	4.5	200	300	205	186	285	80	6	200	300	205	186	285	80	6	M6
	7.5	250	380	225	236	365	75	11	250	380	225	236	365	75	11	M6
	11								400	275						
	15	325	450	285	275	435	75	28	330	675	285	275	435	152.5	32	M6
	22	425	675	350	320	650	125	61	430	985	350	320	650	212.5	67	M10
	30							62							68	
	37	475	800	350	370	775	125	80	480	1110	350	370	775	212.5	87	M10
	45	575	925	400	445	895	150	135	580	1290	400	445	895	270	145	M12
400V Class	4.5	200	300	205	186	285	80	6	200	300	205	186	285	80	6	M6
	7.5	250	380	225	236	365	75	11	250	380	225	236	365	75	11	M6
	9.5															
	13	325	450	285	275	435	75	29	330	610	285	275	435	87.5	M6	
	15							31						34		
	22	325	625	285	275	610	75	44	330	785	285	275	610	87.5	48	M6
	30							850		152.5						
	37	455	820	350	350	795	125	81	460	1130	350	350	795	212.5	87	M10
45	82							88								

\* Mounting holes are the same for the open chassis type and the enclosed wall-mounted type

# APPENDIX 3 TYPICAL CONNECTION DIAGRAM

## 3.1 BRAKING RESISTOR UNIT

For Model CIMR-L5A24P5 (200V Class 4.5kW) ,  
 Models CIMR-L5A44P5 to -L5A49P5 (400 V Class 4.5 to 9.5 kW)

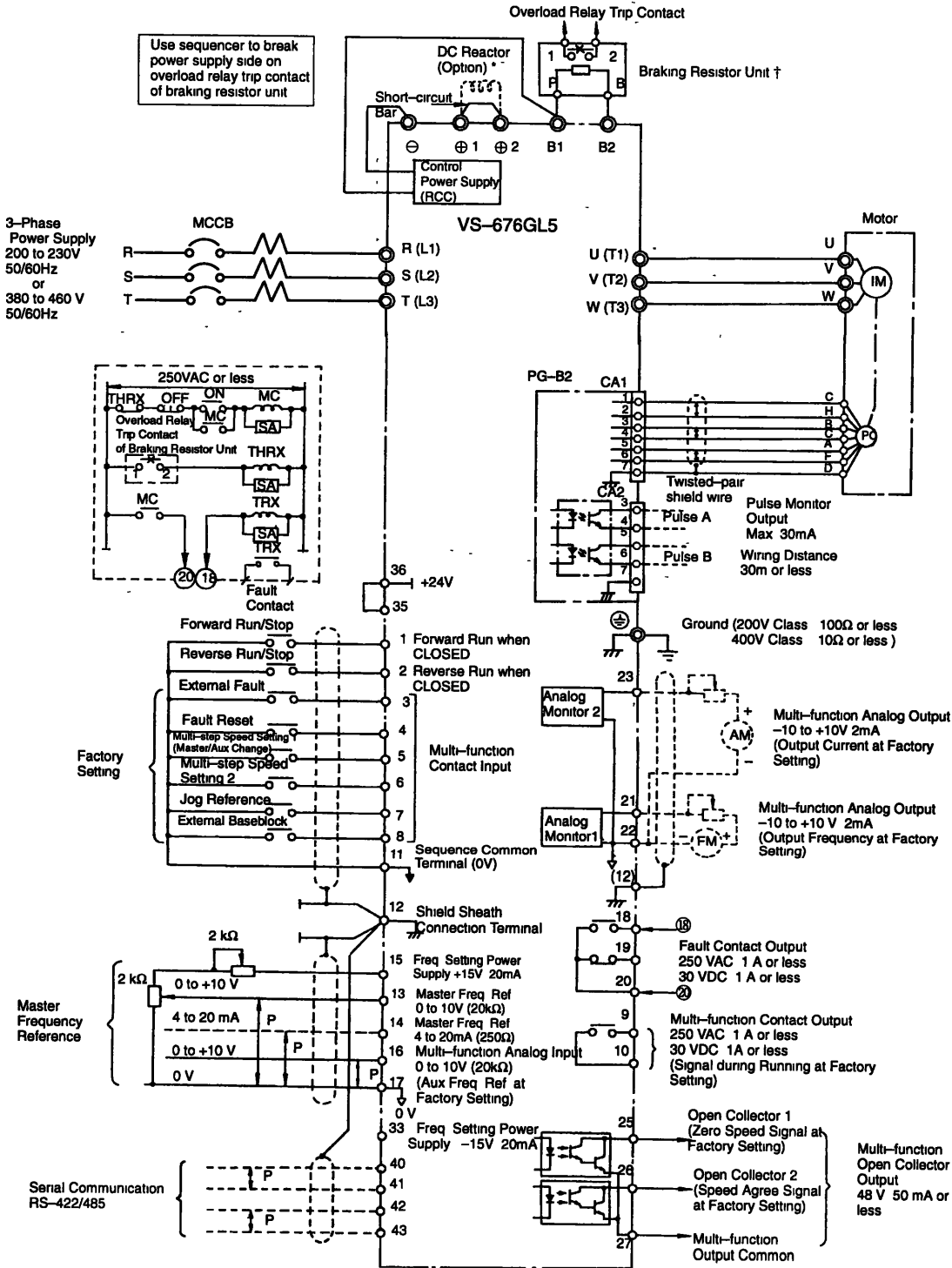

\* When installing a DC reactor (option), remove the common bar between ⊕1 and ⊕2 terminals (provided as standard) and connect a DC reactor with the terminals  
 † When using the braking resistor unit, set constant L3-04 to 0 (stall prevention selection during decel is disabled) If it is not changed, the inverter may not stop within set decel time

### 3.2 BRAKING UNIT AND BRAKING RESISTOR UNIT

For models CIMR-L5A27P5, -L5A2011 (200 V Class 7.5, 11 kW)

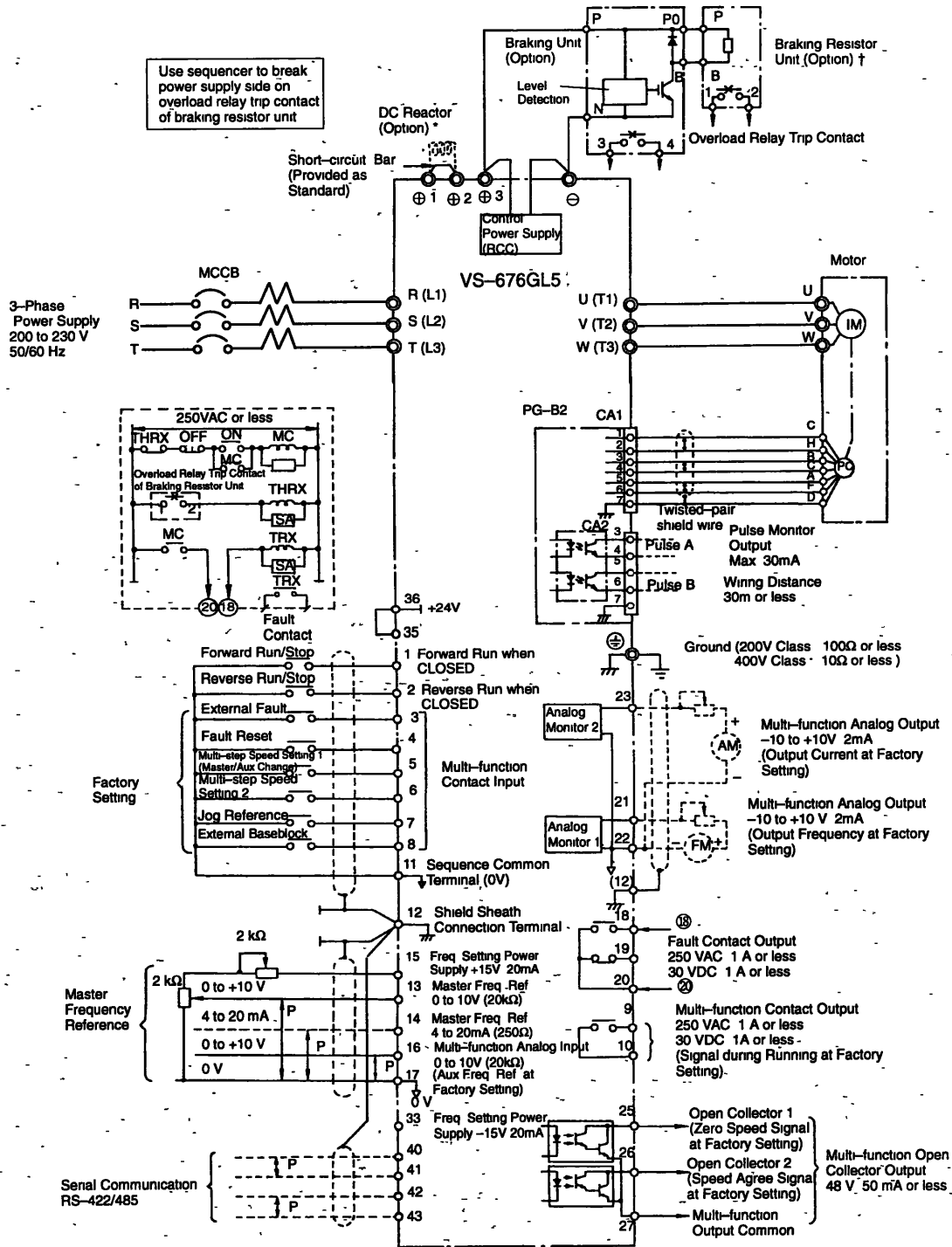

\* When installing a DC reactor (option), remove the common bar between ⊕1 and ⊕2 terminals (provided as standard) and connect a DC reactor with the terminals  
 † When using the braking resistor unit, set constant L3-04 to "0" (stall prevention selection during decel is disabled) If it is not changed, the inverter may not stop within set decel time



### 3.2 BRAKING UNIT AND BRAKING RESISTOR UNIT (Cont'd)

For models CIMR-L5A2015 (200 V Class 15 kW)

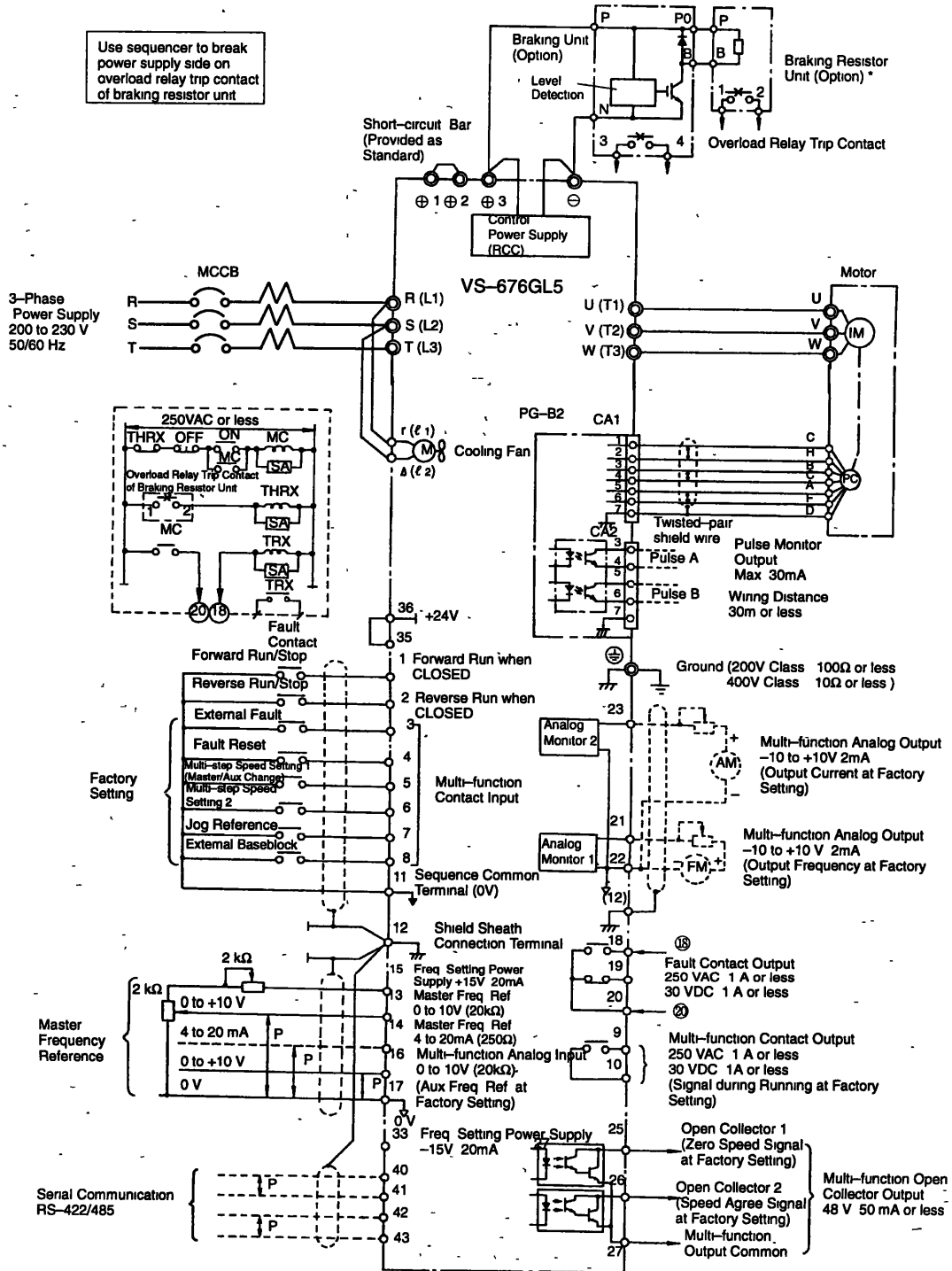

\* When using the braking resistor unit, set constant L3-04 to '0' (stall prevention selection during decel is disabled). If it is not changed, the inverter may not stop within set decel time.

For models CIMR-L5A4013 to -L5A4030 (400 V Class 13 to 30 kW)

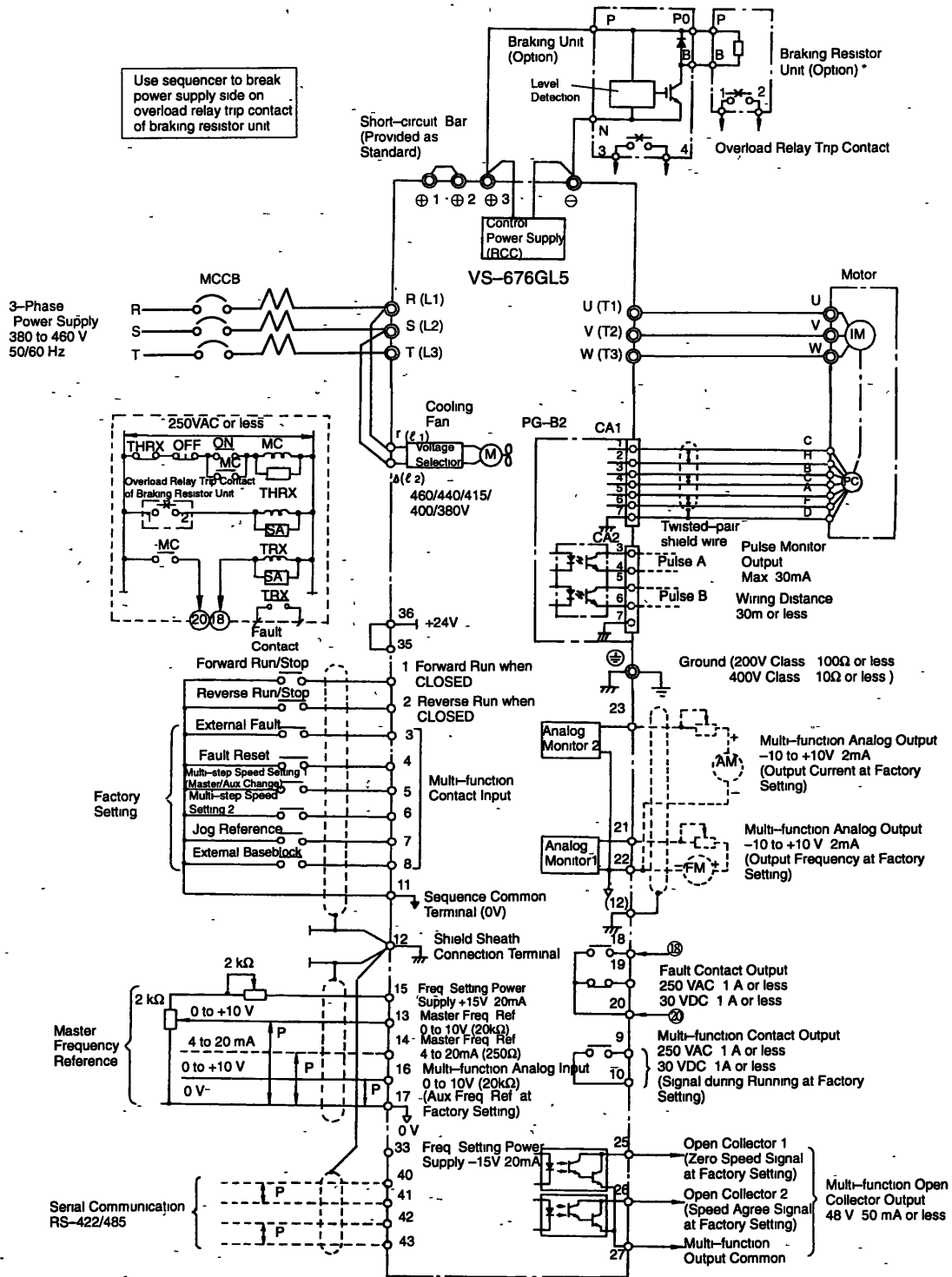

### 3.3 THREE BRAKING UNITS IN PARALLEL

For Models CIMR-L5A2022 to -L5A2045 (200 V Class 22 to 45 kW)

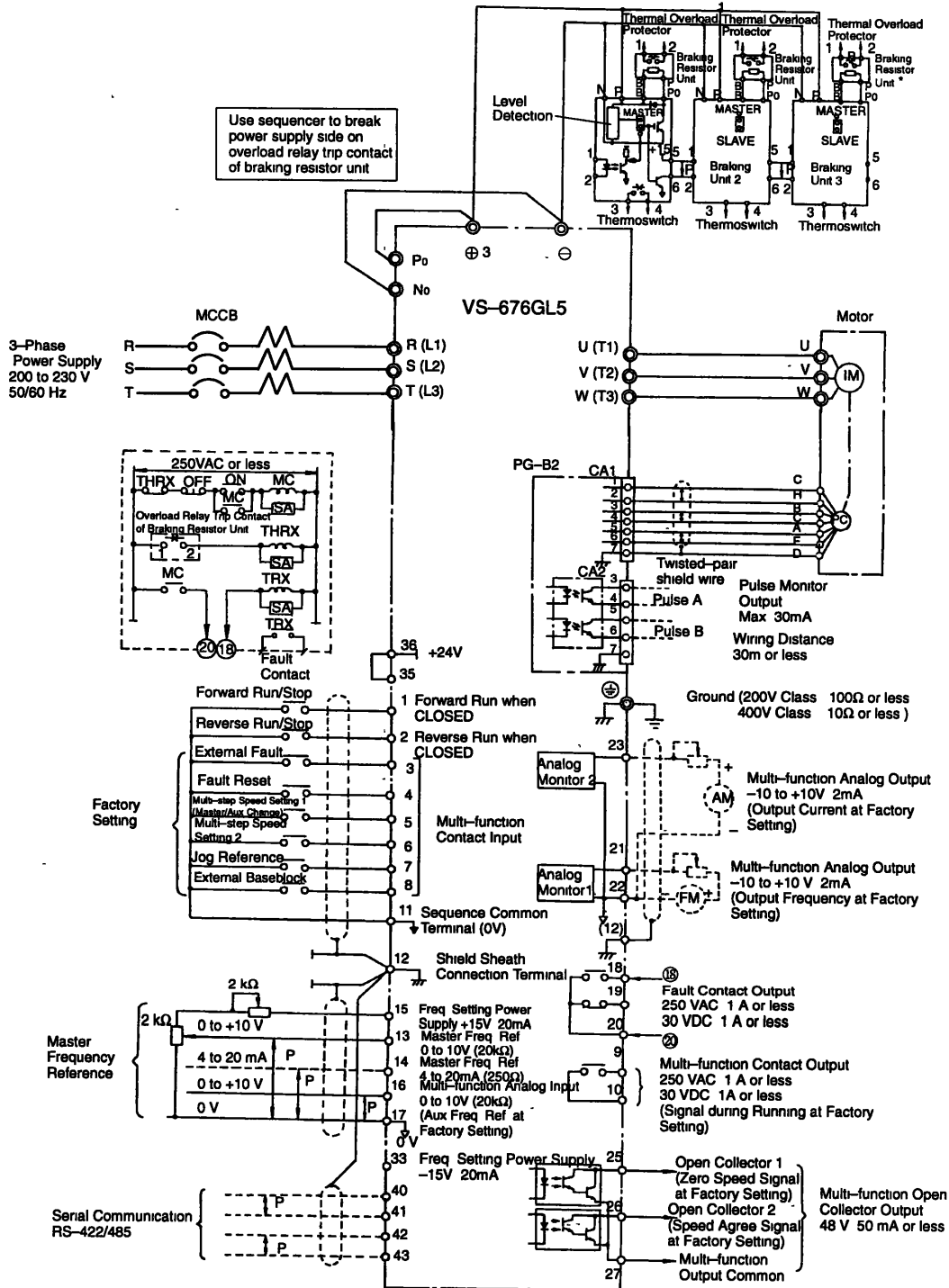

\* When using the braking resistor unit, set constant L3-04 to "0" (stall prevention selection during decel is disabled) If it is not changed, the inverter may not stop within set decel time

For Models CIMR-L5A037, -L5A045 (400V Class 37, 45 kW)

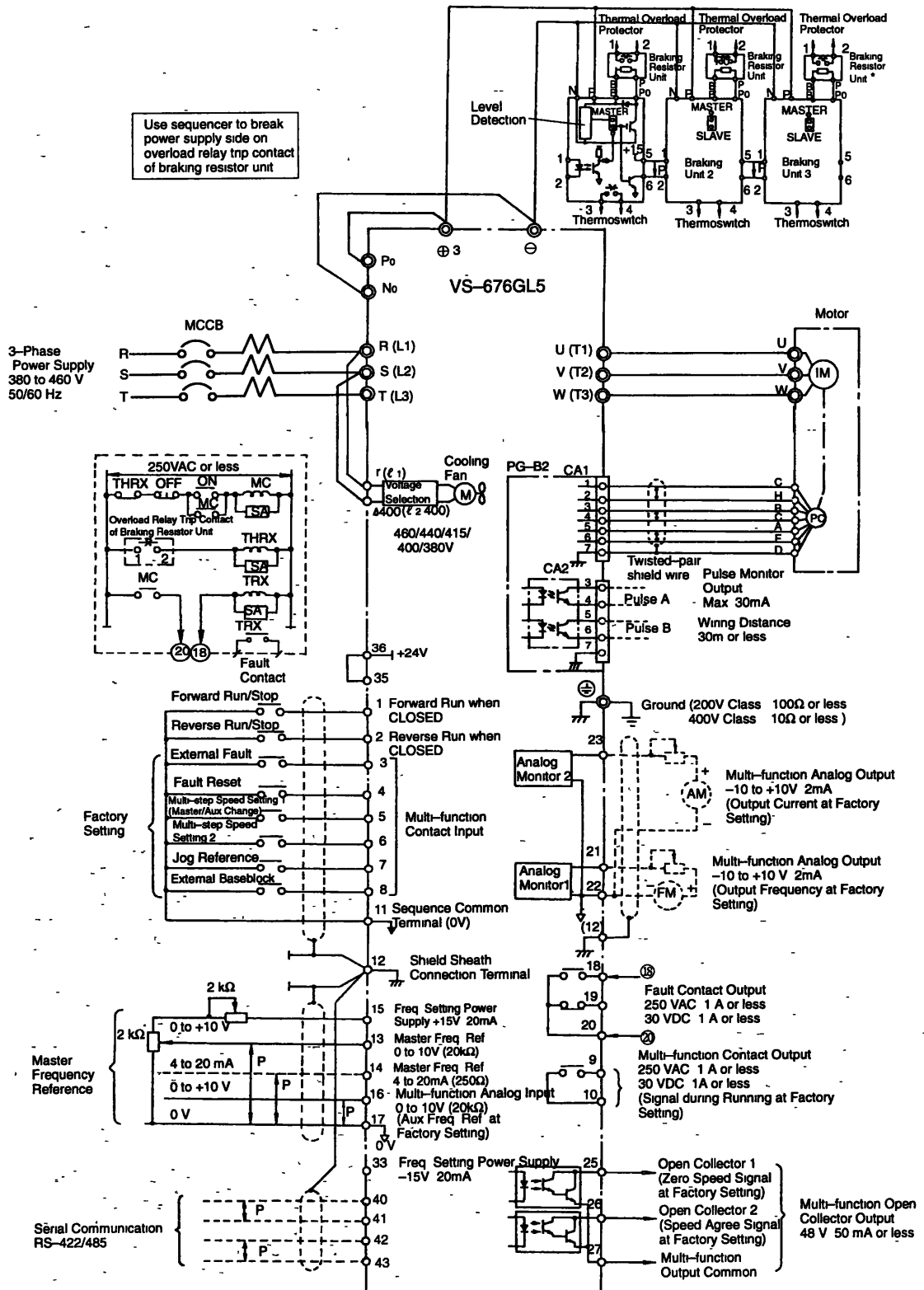

3.4 VS OPERATOR MODELS JVOP-95 AND JVOP-96

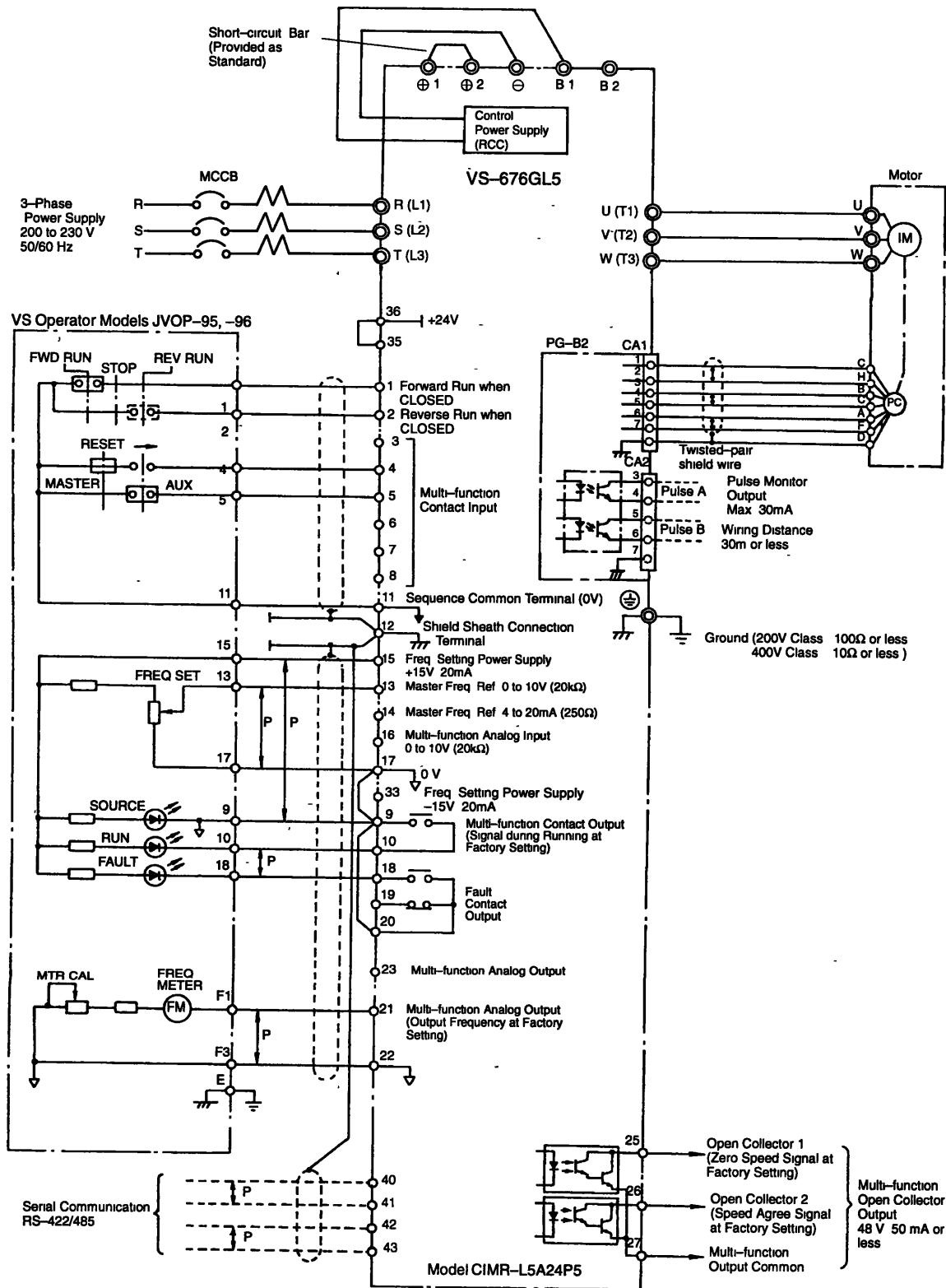

### 3.5 SEQUENCE INPUT AND OUTPUT CONNECTION WITH NPN TRANSISTOR (0V COMMON)

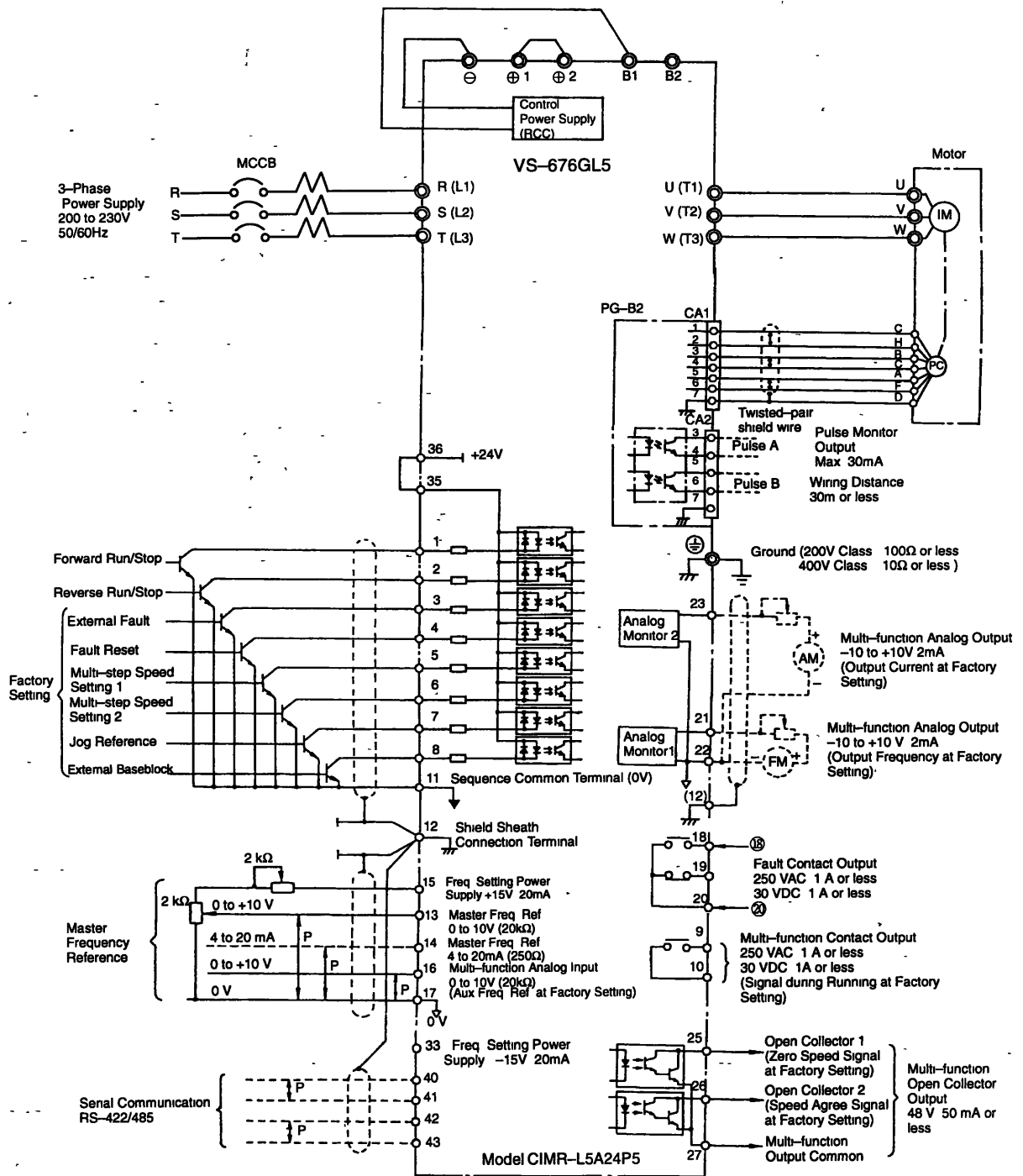

### 3.6 SEQUENCE INPUT AND OUTPUT CONNECTION WITH PNP TRANSISTOR (SUPPLY SIDE COMMON)

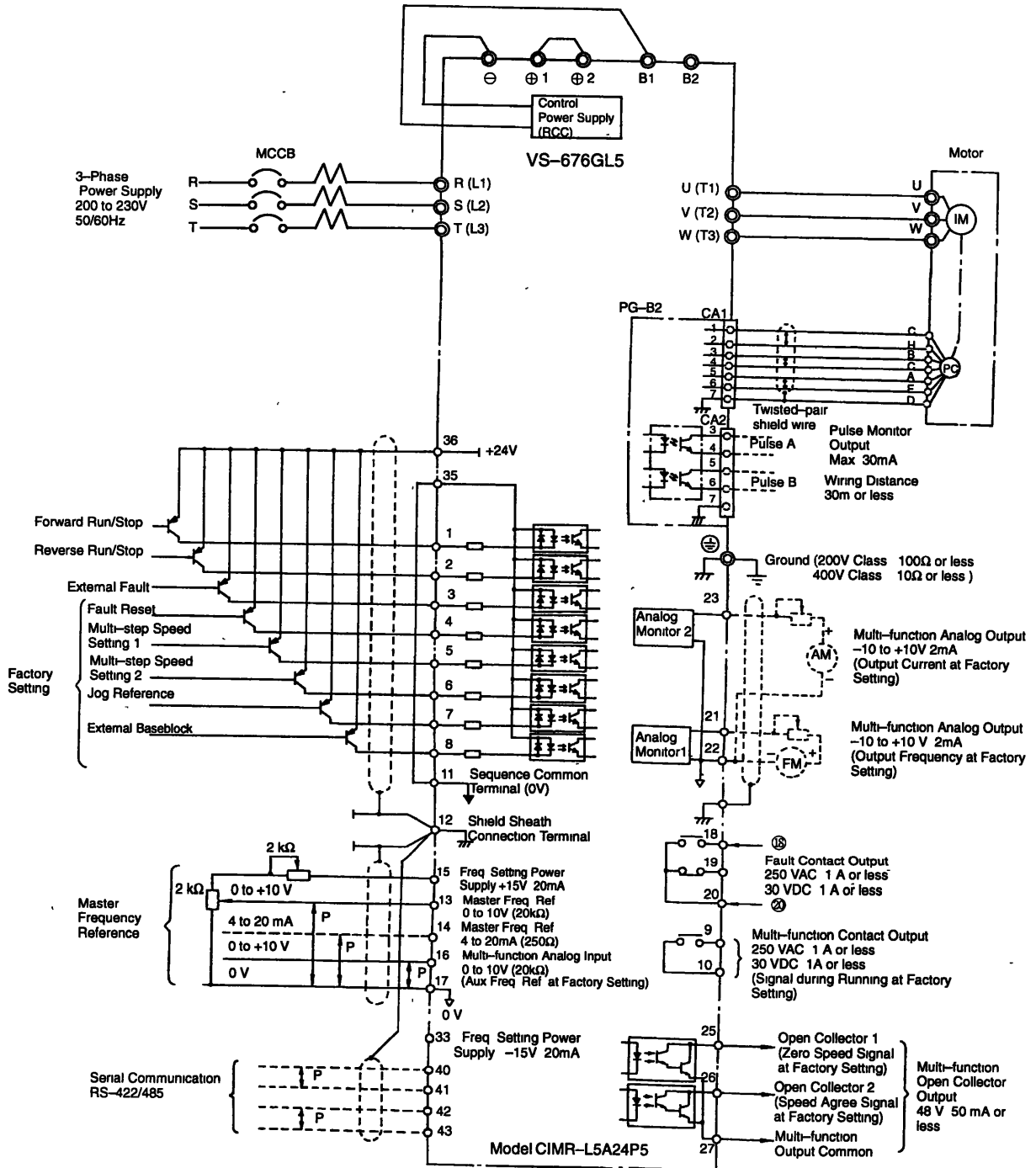

### 3.7 WITH CONTACT OUTPUT, OPEN COLLECTOR OUTPUT

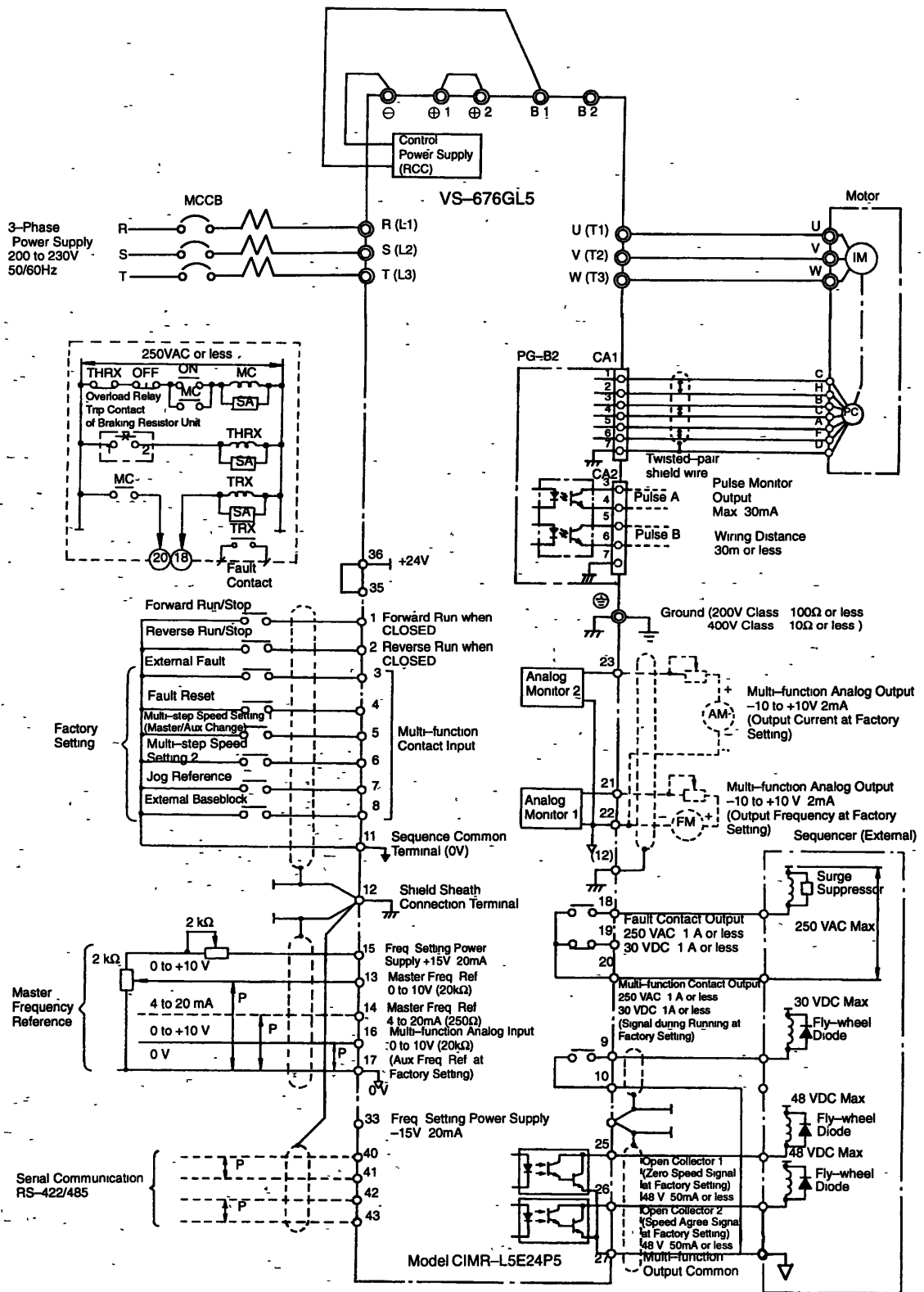



# INDEX

3-phase power supply . . . . . 17

## A

A/D converter fault in analog speed reference card . . . . . 80  
AC reactor . . . . . 20  
accel/decel time . . . . . 82  
access level . . . . . 35, 52  
ADVANCED . . . . . 35, 40, 52  
allowable current . . . . . 29  
allowable frequency fluctuation . . . . . 82  
allowable voltage fluctuation . . . . . 82  
ambient temperature . . . . . 75, 83  
approx. mass . . . . . 86  
auto-tuning mode . . . . . 33, 62  
auxiliary frequency reference . . . . . 29

## B

baseblock circuit fault . . . . . 80  
BASIC . . . . . 35, 39, 52  
blown fuse protection . . . . . 83  
braking resistor unit . . . . . 17, 22, 87  
braking resistor unit overheat . . . . . 78  
braking torque . . . . . 82  
braking transistor failure . . . . . 78  
braking unit . . . . . 22, 88

## C

carrier frequency . . . . . 21  
closed-loop connector . . . . . 28  
connection diagram . . . . . 17  
constant setting fault . . . . . 80  
constant setting range fault . . . . . 79  
contact output . . . . . 96  
control characteristics . . . . . 82  
control circuit . . . . . 29  
control circuit fault . . . . . 80  
control circuit terminal . . . . . 29  
control circuit terminal signal . . . . . 72  
control circuit undervoltage . . . . . 77  
control fault . . . . . 78  
control method . . . . . 52  
control method selection fault . . . . . 79  
control PC board . . . . . 7, 74  
cooling fan . . . . . 22, 75  
CPU external A/D converter fault . . . . . 80  
CPU internal A/D converter fault . . . . . 80

## D

DC reactor . . . . . 20  
digital operator . . . . . 12, 31  
digital operator connection fault . . . . . 78  
dimensions . . . . . 86

## E

EEPROM fault . . . . . 80  
EEPROM writing fault . . . . . 78  
electronic thermal overload relay . . . . . 83  
elevation . . . . . 83  
emergency stop circuit . . . . . 4, 16  
enclosed wall-mounted type . . . . . 11, 83  
enclosure . . . . . 11  
environment . . . . . 83  
external baseblock . . . . . 17, 29  
external fault . . . . . 17, 29, 79

## F

fault contact output . . . . . 17, 76  
fault diagnosis . . . . . 76  
fault reset . . . . . 17, 29  
flux vector . . . . . 52  
fly-wheel diode . . . . . 29, 96  
forward run . . . . . 17  
frequency accuracy . . . . . 82  
frequency control range . . . . . 82  
frequency reference . . . . . 66  
frequency resolution . . . . . 82  
frequency setting power supply . . . . . 17  
frequency setting signal . . . . . 82  
fuse blown . . . . . 77

## G

ground fault . . . . . 83  
ground fault interrupter . . . . . 19  
ground terminal . . . . . 4, 19  
grounding . . . . . 21, 77

## H

heatsink overheat . . . . . 77, 83  
heatsink overheat alarm . . . . . 77  
humidity . . . . . 83

<b>I</b>	
initialize	54
initialize mode	33, 50
input open-phase	78
instantaneous overcurrent	83
intake air	15
inverter overload	77

<b>J</b>	
jog frequency reference	17, 29

<b>K</b>	
kVA selection fault	79

<b>L</b>	
line voltage	67
load	20
load short-circuit	77
LOCAL	66
location	83

<b>M</b>	
magnetic contactor	19, 20
magnetic starter	20
main circuit	19
main circuit configuration	24
main circuit power supply	19, 74
main circuit terminal	22
main circuit undervoltage	77
master frequency reference	17, 29
max. applicable motor output	11, 82
max. output voltage	82
MC fault	77
modified constants mode	33, 64
molded-case circuit breaker	7, 19, 74
momentary power loss	77, 83
motor overload	77
motor overload protection	84
multi-function analog input	17, 29
multi-function analog input selection fault	79
multi-function analog output	17
multi-function contact input	17
multi-function contact input selection fault	79
multi-function contact output	17
multi-function input/output selection fault	79
multi-function open collector output	17
multi-function output common	17
multi-step speed reference	29
multi-step speed setting	17

<b>N</b>	
nameplate	10

<b>O</b>	
open chassis type	11, 83
open collector	17
open collector output	96
open collector output common	29
open loop vector	52
open phase	81
operation mode	33, 41
operation reference fault	78
option connection fault	80
option reference selection fault	79
output characteristics	82
output current	17
output frequency	17
output frequency resolution	82
output open-phase	78
output terminal	20
overcurrent	77
overload	83
overload capacity	82
overload relay trip contact	87
overspeed	78
overtorque detection	77
overvoltage	77, 83

<b>P</b>	
periodic inspection	75
PG open circuit	78
phase advancing capacitor	20
photo-coupler insulation	29
power charge indication	83
power supply	82
programming mode	33, 61

<b>Q</b>	
QUICK-START	35, 37, 52

<b>R</b>	
rated input voltage and frequency	82
rated output current	82
rated output frequency	82
REMOTE	66
reverse run	17

<b>S</b>	
sequence common	17
sequence control input common	29
sequencer	96
shield sheath connection terminal	17
shielded wire	18
shortcircuit	20
sine wave PWM	82

specifications	82
speed agree detection	29
speed agree signal	17
speed control accuracy	82
speed control range	82
speed deviation	78
speed response	82
stall prevention	83
starting torque	82
storage temperature	83
surge suppressor	20
switching frequency	21

## T

terminal screw	26
test run	67, 68
thermal overload protector	91
thermal overload relay	21
thermistor	83
thermoswitch	91
torque accuracy	82
torque limit	82
transmission error	78

twisted shielded wire	26
twisted-pair shielded wire	18, 30

## U

undervoltage	83
user constants	56

## V

V/f data setting fault	80
vibration	83
VS operator	93

## W

warning label	8
wire size	26
withstand voltage test	5, 16

## Z

zero-servo fault	78
zero speed detection	29
zero speed signal	17

# VARISPEED-676GL5

# INSTRUCTION MANUAL

---

**TOKYO OFFICE**

New Pier Takeshiba South Tower, 1-16-1, Kaigan, Minatoku, Tokyo 105 Japan  
Phone 81-3-5402-4511 Fax 81-3-5402-4580

**YASKAWA ELECTRIC AMERICA, INC.****Chicago-Corporate Headquarters**

2942 MacArthur Blvd Northbrook, IL 60062-2028, U S A  
Phone 1-847-291-2340 Fax 1-847-498-2430

**Chicago-Technical Center**

3160 MacArthur Blvd Northbrook, IL 60062-1917, U S A  
Phone 1-847-291-0411 Fax 1-847-291-1018

**MOTOMAN INC. HEADQUARTERS**

805 Liberty Lane West Carrollton, OH 45449, U S A  
Phone 1-937-847-6200 Fax 1-937-847-6277

**YASKAWA ELETRICO DO BRASIL COMERCIO LTDA.**

Avenida Brigadeiro Faria Lima 1664-5' C.J 504/511, Sao Paulo, Brazil  
Phone 55-11-815-7723 Fax 55-11-870-3849

**YASKAWA ELECTRIC EUROPE GmbH**

Am Kronberger Hang 2, 65824 Schwalbach, Germany  
Phone 49-6196-569-300 Fax 49-6196-888-301

**Motoman Robotics AB**

Box 504 S38525 Torsas, Sweden  
Phone 46-486-48800 Fax 46-486-41410

**Motoman Robotec GmbH**

Kammerfeldstraße 1, 85391 Allershausen, Germany  
Phone 49-8166-900 Fax 49-8166-9039

**YASKAWA ELECTRIC UK LTD.**

3 Drum Mains Park, Orchardton Woods, Cumbernauld, Scotland, G68 9LD, United Kingdom  
Phone 44-1236-735000 Fax 44-1236-458182

**YASKAWA ELECTRIC KOREA CORPORATION**

Paik Nam Bldg 901 188-3, 1-Ga Euljiro, Joong-Gu Seoul, Korea  
Phone 82-2-776-7844 Fax 82-2-753-2639

**YASKAWA ELECTRIC (SINGAPORE) PTE. LTD.**

151 Lorong Chuan, #04-01, New Tech Park Singapore 556741, Singapore  
Phone 65-282-3003 Fax 65-289-3003

**YATEC ENGINEERING CORPORATION**

Shen Hsiang Tang Sung Chiang Building 10F 146 Sung Chiang Road, Taipei, Taiwan  
Phone 886-2-563-0010 Fax 886-2-567-4677

**BEIJING OFFICE**

Room No 301 Office Building of Beijing International Club, 21  
Jianguomenwai Avenue, Beijing 100020, China  
Phone 86-10-6532-1850 Fax 86-10-6532-1851

**SHANGHAI OFFICE**

27 Hui He Road Shanghai 200437 China  
Phone 86-21-6553-6600 Fax 86-21-6531-4242

**YASKAWA JASON (HK) COMPANY LIMITED**

Rm 2909-10, Hong Kong Plaza, 186-191 Connaught Road West, Hong Kong  
Phone 852-2803-2385 Fax 852-2547-5773

**TAIPEI OFFICE**

Shen Hsiang Tang Sung Chiang Building 10F 146 Sung Chiang Road, Taipei, Taiwan  
Phone 886-2-563-0010 Fax 886-2-567-4677

**SHANGHAI YASKAWA-TONGJI M & E CO., LTD.**

27 Hui He Road Shanghai China 200437  
Phone 86-21-6531-4242 Fax 86-21-6553-6060

**BEIJING YASKAWA BEIKE AUTOMATION ENGINEERING CO., LTD.**

30 Xue Yuan Road, Haidian, Beijing P R China Post Code 100083  
Phone 86-10-6233-2782 Fax 86-10-6232-1536

**YASKAWA****YASKAWA ELECTRIC CORPORATION**

Specifications are subject to change without notice  
for ongoing product modifications and improvements